



LASER CATALOG

A PROGRESSIVE COMPANY FOR AN EVOLVING MARKET



Over a period of 28 years, the THERMACUT® Group has undergone a multitude of changes. THERMACUT® (originally Tatra Imports Inc.) was incorporated in Claremont, New Hampshire in 1990 and sold products under the brand ZAP Plasmatherm, a reseller of plasma consumables from local vendors directly to end-users. The company began operating with three employees, conducting business through telephone sales. In 1992, the company opened a small manufacturing facility in the Czech Republic, followed by a sales office there in 1996. The Czech facility was created to produce and sell plasma consumables and torches directly into the Eastern European market and through distributors in Western Europe under the brand name THERMACUT®, utilizing both inside and outside sales representatives. And in 1993 the THERMACUT® brand was introduced into North America and sold through distributors.

In January of 1999, STK Gesellschaft für Schweißtechnik GmbH (a holding company 100% owned by the IBG Group of Cologne, Germany) purchased 80% of the shares of THERMACUT® and in 2002 completed the acquisition to become the 100% shareholder of the THERMACUT® Group.

Since those early and humble beginnings, THERMACUT® has evolved into a major force in providing plasma torches and consumables through multiple sales channels supported by ten sales subsidiaries. THERMACUT® also has a close partnership with Abicor-Binzel (an IBG owned company) with locations in India, the Middle East, Turkey, Belarus, Kazakhstan, Denmark, Norway, Sweden, Finland, United Kingdom, South Korea, Australia, Mexico, and Brazil. Based on customer demand, THERMACUT® has also introduced TIG/WIG, MIG/MAG and Oxy-fuel products and produces those products at its modern ISO 9001 production facility located in Uherske Hradiste in the Czech Republic.

The THERMACUT® Group has focused its efforts on providing high quality, direct replacement consumable and torch product lines that will meet or exceed the expectations of our valued customers who are cutting and welding metals thermally throughout the world. As our customer base grew, their expectations and demands also increased. In 2005, THERMACUT® expanded its product portfolio with the addition of advanced consumables, which have included products such as the Silver Plus™, Silver Pro™ and Silver-EX® electrodes, plus the patented Tungsten-EX™ nozzles.

By 2013, the THERMACUT® Group continued to expand and evolve in the thermal cutting and welding marketplace. In December of 2012, the THERMACUT® Group concluded the purchase of the HOLMA® AG, a producer of premium quality laser consumables, which satisfies ongoing requests from customers for a high quality laser consumable brand and a further expansion of THERMACUT's plasma cutting and oxy-fuel consumable product portfolio.

In September 2013 at the SCHWEISSEN & SCHNEIDEN Exposition, the THERMACUT® Group evolved once again with the introduction of a line of plasma cutting systems for both manual and mechanized plasma processes up to 65 mm thickness. The initial introduction featured a 105 amp system. THERMACUT® also had 65 and 85 amp systems on display. With this change, THERMACUT® has made clear to its customers around the world its intention to move into the position of a producer of a full range of original plasma products.

From 2016 to 2018, plasma power sources from 30 A to 125 A were gradually introduced. The HD series, along with its original torches and the patented Torch Connection System (TCS) connector, was launched in 2017 at SCHWEISSEN & SCHNEIDEN in Dusseldorf.

As with plasma cutting, THERMACUT® is the leader in the field of laser cutting technology. In 2017 at SCHWEISSEN & SCHNEIDEN, we presented the original EX-TRABEAM® laser head, which was launched in the second half of 2018.

Throughout the life of the THERMACUT® Group, we have believed that "The customer is always right." This is what motivates us to improve in all areas, starting with the development of all products and ending their sales.

"THE CUTTING COMPANY" is not just a slogan for us. It is an established practice. Join THERMACUT® in the world of cutting to discover new and alternative applications, and take full advantage of new possibilities offered by the digital cutting world.



ADDRESSES AND CONTACTS

CZECH REPUBLIC

THERMACUT, k.s.
Headquarters and Production
Sokolovská 574, Mařatice
686 01 Uherské Hradiště
Tel.: +420 572 420 411
Fax: +420 572 420 420
E-mail: info@thermacut.cz
reditelstvi@thermacut.cz
www.thermacut.cz

CZECH REPUBLIC

THERMACUT, k.s.
Central Sales Department
Dukelská 76A
742 42 Šenov u Nového Jičína
Tel.: +420 556 423 418, 440
E-mail: sales@thermacut.cz
obchod@thermacut.cz
www.thermacut.cz

GERMANY

THERMACUT GMBH
Am Rübgarten 2
D-57299 Burbach
Tel.: +49 2736 294911-0
Fax: +49 2736 294911-77
E-mail: info@thermacut.de
www.thermacut.de

USA

THERMACUT, Inc
153 Charlestown Road
Claremont, NH 03743
Tel.: +1 (800) 932-8312
+1 (603) 543-0585
Fax: +1 (800) 972-6255
+1 (603) 542-2867
E-mail: sales@thermacut.com
www.thermacut.com

SUBSIDIARIES

CROATIA

THERMACUT CROATIA d.o.o.
Petra Preradovića 21
532 70 Senj
Tel.: +385 53 882 622
E-mail: thermacut@gs.t-com.hr
www.thermacut.hr

HUNGARY

THERMACUT HUNGÁRIA Kft.
Petőfi Sándor utca 37 atd.
2500 Esztergom
Tel.: +36 33 502 090,1
Fax: +36 33 400 004
E-mail: info@thermacut.hu
www.thermacut.hu

CHINA

TMT (Shanghai) Cutting and Welding
Equipment Co., Ltd.
Room 206 2/F, B Block, Eternal Asia Plaza,
No. 3333 Shenjiang Road, Shanghai
Post: 201206
Tel.: 021-50390667
Fax: 021-50390677
E-mail: thermacut@weldstone.cn

JAPAN

Thermacut Japan Ltd.
3F Shin-Osaka Hankyu Building
1-1-1, Miyahara, Yodogawa-ku, Osaka
532-0003 Japan
Mob.: +81 (0)80 4738 9752
Tel.: +81 (0)6 7662 8857
Fax: +81 (0)6 7668 8301
E-mail: s.miura@thermacut.jp

SUBSIDIARIES

POLAND

THERMACUT-POLAND Sp. z o.o.
ul. Stawowa 20
43-400 Cieszyn
Tel.: +48 33 852 39 71
Tel./Fax: +48 33 852 13 34
E-mail: thermacut@pro.onet.pl
www.thermacut.pl

ROMANIA

THERMACUT ROMANIA SRL
B-dul 1 Decembrie 1918
nr. 127A
540445 Targu Mures,
Jud. Mures
Tel.: +40 265 263 205
Fax: +40 265 250 317
E-mail: office@thermacut.ro
www.thermacut.ro

RUSSIA

ООО "ТЕРМАКАТ"
454048Г. ЧЕЛЯБИНСК
УЛ. КИРОВОГРАДСКАЯ Д.2
Тел./факс: +7 351 211 08 15

ФИЛИАЛЫ

129343 Г. МОСКВА
УЛ. УРЖУМСКАЯ Д.4
Тел.: +7 495 778 42 10

630032 Г. НОВОСИБИРСК
УЛ. СТАНЦИОННАЯ 60/1, ОФИС 116
Тел.: +7 383 375 07 90

E-mail: info@thermacut.ru
www.thermacut.ru

SLOVAKIA

THERMACUT SLOVAKIA, s.r.o.
Priemysel'na' 1239
931 01 Šamorín
Tel.: +421 31 591 0121
+421 31 591 0122
E-mail: obchod@thermacut.sk
www.thermacut.sk

UKRAINE

ООО "Термакат Украина ГмбХ"
ул. Петропавловская 24
с. Петропавловская Борщаговка
Киево-Святошинский р-н 08130
Моб. тел.: +380 50 336 33 91
Тел./факс: +380 44 403 16 99
E-mail: info@thermacut.ua
www.thermacut.ua

SALES COOPERATION WITH ABICOR-BINZEL

AUSTRALIA

Binzel PTY Ltd.
42 Hinkler Road
Mordialloc
Victoria 3195
Tel.: +61 (0)3 9587 8522
Fax: +61 (0)3 9580 8796
E-mail: sales@thermacut.com.au

BELARUS

IOOO «ABICOR BINZEL Technics»
ul. Timirjazeva 97-10
BY-220020 Minsk
Tel.: +375 29 5 800 300
E-mail: info@thermacut.by

BRAZIL

BINZEL DO BRASIL INDUSTRIAL Ltda
Estrada União e Indústria, Km 15,5-Lt 17,
Pedro do Rio,
Petrópolis - Rio de Janeiro, CEP 25750-226
Tel.: +55 (24) 2222-9799
+55 (24) 2222-9789
Mob.: +(24) 98134-2676
Fax: +55 (24) 2222-9789
E-mail: thermacut@thermacut.com.br
www.thermacut.com.br

DENMARK

Abicor Binzel A/S Denmark
Ringugngsgatan 4
SE-216 16 Limhamn
Tel.: 0045-43621633
Fax: 0045-43622324
E-mail: ac@binzel.se, ket@binzel.se
www.binzel-abicor.com

FINLAND

ABICOR BINZEL Finland Oy
Kartanontie 53
28430 Pori
Tel.: +358 2 634 4600
Fax: +358 2 634 4650
E-mail: info@binzel.fi

FRANCE

THERMACUT FRANCE
6 Rue des Frères Lumiere
67201 Eckbolsheim
Tel.: +33 3 88 76 58 75
E-mail: thermacut@thermacut.fr
www.thermacut.fr

GREAT BRITAIN

Abicor Binzel UK Ltd
Binzel House,
Mill Lane
Winwick Quay
Warrington,
WA2 8UA,Cheshire
Tel.: +44 1925 653944
Fax: +44 1925 654861
E-mail: info@abimail.co.uk
www.thermacut.uk

INDIA

ABICOR BINZEL TECHNOWELD PVT LTD
SNo: 297, Indo German Technology park
Urawade
Mulshi
Pune- 412 115
Phone: 020-66743914, 020-39502691
E-mail: commercial@abicor-india.com

KAZAKHSTAN

THERMACUT
Республика Казахстан.
010000, г. Астана
пр. Республики 68, БЦ «Маржан» офис 116
Моб.: +7 777 826 4242
Тел.: +7 717 262 5730
E-mail: info@thermacut.com.kz
www.thermacut.kz

SALES COOPERATION WITH ABICOR-BINZEL

MEXICO

BINZEL MEXICO S.A. de C.V.
C. Municipio de Tepezalá No. 109
de Arteaga No. 102
Valle de Ags., C.P. 20358
San Fco. de los Romo, Ags.
Tel.: +52 (449) 1581765
Fax: +52 (449) 9731388
E-mail: info@thermacut.com.mx
www.thermacut.com.mx

NORWAY

Binzel Norge AS
Industriveien 6
N-3300 Hokksund
Tel.: 0047-32 25 19 90
E-mail: post@binzel.no

SOUTH KOREA

Abicor Binzel Korea Ltd.
#A-101, 263, Gaejwa-ro
Guemjeong-gu
Busan
Tel.: 0082 (31) 732 6065 / 6066 / 6067
Fax: 0082 (31) 732 6064
E-mail: don.kim@binzel.kr

SWEDEN

Alexander Binzel AB
Ringugngsgatan 4
S-21616 Limhamn
Tel.: 0046- 40 6 991 750
Fax: 0046- 40 6 991 770
E-mail: order@binzel.se

TURKEY

ABICOR BINZEL Kaynak Teknik
Ticaret LTD. STI.
Girne Mah. Irmak Sok. Küçükyali İş Merkezi E
Blok
No:72-6E PK:34852
Maltepe İstanbul Türkiye
Tel.: +90 (216) 367 90 00
Fax: +90 (216) 367 90 14
E-mail: satisdestek@binzel-abicor.com.tr
www.thermacuttr.com

UNITED ARAB EMIRATES

ABICOR BINZEL MIDDLE EAST FZE
P.O Box: 86026, WFZ-04/27, RAKIA Freezone,
Jazeera al Hamra
Ras al Khaimah, United Arab Emirates
Mob.: +971 50 377 1348
Tel.: +971 (7) 2432355
Fax: +971 (7) 2432356
E-mail: info@binzel-abicor.ae

VIETNAM

MNT Industries Vietnam Co Ltd
No. 17, Street 34, Binh Tri Dong B Ward, Binh
Tan District, Hochiminh City
Tel.: 0084-903 858 001
E-mail: ezio.minh@mnt.com.vn

TABLE OF CONTENTS

LASER

SYSTEM	PAGE
THERMACUT® REPLACEMENT PARTS SUITABLE FOR AMADA®	8-10
BYSTRONIC®	11-13
AIR FILTERS suitable for BYSTRONIC®	13
CINCINNATI®	14
MAZAK®	15-17
MAZAK® (FOR US MARKET ONLY)	18-22
MITSUBISHI®	23-24
Precitec®	25-30
PRIMA POWER®	31-32
TRUMPF®	33-40
AIR FILTERS suitable for TRUMPF®	41
RAYTOOLS™	42
BODOR™	42

THERMACUT®, THE CUTTING COMPANY®, FHT-EX®, EX-TRAFIRE®, EX-TRACK®, EX-TRABEAM® AND EX-TRAFLEAME® ARE REGISTERED TRADEMARKS OF THERMACUT, K.S. AND MAY BE REGISTERED IN CZECH REPUBLIC AND/OR OTHER COUNTRIES. ALL OTHER TRADEMARKS ARE PROPERTIES OF THEIR RESPECTIVE OWNERS. THERMACUT® IS NO WAY AFFILIATED WITH AMADA®, BODOR™, BYSTRONIC®, CINCINNATI®, MAZAK®, MITSUBISHI®, Precitec®, PRIMA POWER®, RAYTOOLS™, TRUMPF®.

THERMACUT® REPLACEMENT PARTS SUITABLE FOR AMADA®

Part No.	Ref. No.	Description	Std. Pkg.	Part No.	Ref. No.	Description	Std. Pkg.
HG11.521	AL360	Nozzle Holder	1pc	HG11.522	AL392	Nozzle Holder Insert	1pc

SUITABLE FOR AMADA® LASER AHS™ 100

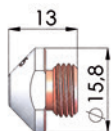

HG10.508

Part No.	Ref. No.	Description	Std. Pkg.	Part No.	Ref. No.	Description	Std. Pkg.
HG10.508	62094006-1.3	Nozzle 1.3mm M10 × 1 HCP	10pcs	HG10.506	62094006-2.0	Nozzle 2.0mm M10 × 1 HCP	10pcs

SUITABLE FOR AMADA® F.O.™

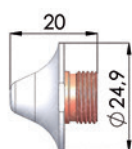

HG10.608–HG10.614, HG10.619

Standard/Double copper nozzles with chromium plating

Part No.	Ref. No.	Description	Std. Pkg.	Part No.	Ref. No.	Description	Std. Pkg.
HG10.609	1572362-0.8	Nozzle 0.8mm HCP	10pcs	HG10.594	1572361-1.2	Double Nozzle 1.2mm HCP	10pcs
HG10.619	1572359	Nozzle 1.0mm HCP	10pcs	HG10.592	1572361-1.4	Double Nozzle 1.4mm HCP	10pcs
HG10.610	1572362-1.2	Nozzle 1.2mm HCP	10pcs	HG10.595	1572361-2.0	Double Nozzle 2.0mm HCP	10pcs
HG10.613	1572362-1.4	Nozzle 1.4mm HCP	10pcs	HG10.618	1572361-2.5	Double Nozzle 2.5mm HCP	10pcs
HG10.608	1572362-1.5	Nozzle 1.5mm HCP	10pcs	HG10.599	1572361-3.0	Double Nozzle 3.0mm HCP	10pcs
HG10.611	1572362-2.0	Nozzle 2.0mm HCP	10pcs	HG10.593	1572361-4.0	Double Nozzle 4.0mm HCP	10pcs
HG10.612	1572362-3.0	Nozzle 3.0mm HCP	10pcs	HG10.759	71515853	PTFE ring	1pc
HG10.614	1572362-4.0	Nozzle 4.0mm HCP	10pcs				

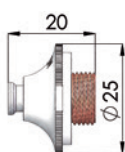

HG10.763, HG10.765, HG10.766

Part No.	Ref. No.	Description	Std. Pkg.	Part No.	Ref. No.	Description	Std. Pkg.
HG10.763	HG10.763	WACS - Double Nozzle 1.7mm with holes Hard chrom (PTFE Ring included)	1pc	HG10.766	71712336	WACS - Double Nozzle 4.0mm with holes Hard chrom (PTFE Ring included)	1pc
HG10.765	71712335	WACS - Double Nozzle 2.5mm with holes Hard chrom (PTFE Ring included)	1pc	HG10.773	71341728	Clean Cut Double Nozzle 4.0mm HCP	1pc
				HG10.776	71341729	Clean Cut Double Nozzle 7.0mm HCP	1pc

PolyTetraFluoroEthylene is a fluorocarbon-based polymer and is commonly abbreviated PTFE. The Teflon® brand of PTFE is manufactured only by DuPont® and is not sold by THERMACUT®. THERMACUT® purchases other brands of PTFE from various high quality manufacturers.

Last update of this page: 22/08/2022. See Revision history for details.

THERMACUT® REPLACEMENT PARTS SUITABLE FOR AMADA® AMADA® LC-3015 X1™

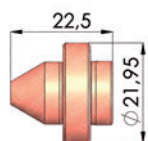

HG12.507

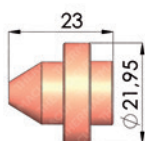

HG12.508

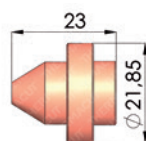

HG12.509

Part No.	Ref. No.	Description	Std. Pkg.	Part No.	Ref. No.	Description	Std. Pkg.
HG11.500	HG11.500	Nozzle 0.8mm Fe CP	10pcs	HG12.531	OD HG12.531	Nozzle 1.7mm	10pcs
HG11.501	71570021	Nozzle 1.0mm Fe CP	10pcs	HG12.508	BQ943D157H02	Nozzle 2.0mm	10pcs
HG11.502	71570020	Nozzle 1.2mm Fe CP	10pcs	HG12.509	BQ943D157H03	Nozzle 2.5mm	10pcs
HG11.503	HG11.503	Nozzle 1.4mm Fe CP	10pcs	HG12.520	BQ943D269H01	Nozzle 1.2mm	10pcs
HG11.504	71570022	Double Nozzle 2.0mm Fe CP	10pcs	HG12.530	BQ933D094H01	Nozzle Nut, Short (length 15mm)	1pc
HG11.505	HG11.505	Double Nozzle 2.5mm Fe CP	10pcs	HG12.501	BQ943D156H01	Double Nozzle Insert 8-holes	10pcs
HG11.506	HG11.506	Double Nozzle 4.0mm Fe CP	10pcs	HG12.504	BQ943D156H03	Double Nozzle Insert 24-holes	10pcs
HG12.507	BQ943D157H01	Nozzle 1.5mm	10pcs				

LENSES SUITABLE FOR AMADA® LC-3015 X1™



Part No.	Ref. No.	Description	Std. Pkg.	Part No.	Ref. No.	Description	Std. Pkg.
HG15.029/H	OD HG15.029/H	5.00" ZnSe Plano-convex lens High pressure lens (19bar), 50.8mm Effective focal length: 127.0mm Edge thickness: 7.87mm AR/AR for 10.6µm (absorption <0.20%)	1pc	HG15.029/HU	HG15.029/HU	5.00" ZnSe Plan.-con. - ULTRA LOW High pressure lens (19bar), 50.8mm Effective focal length: 127.0mm Edge thickness: 7.87mm AR/AR for 10.6µm (absorption <0.13%)	1pc
HG15.028/H	HG15.028/H	7.50" ZnSe Plano-convex lens High pressure lens (19bar), 50.8mm Effective focal length: 190.5mm Edge thickness: 7.87mm AR/AR for 10.6µm (absorption <0.20%)	1pc	HG15.028/HU	HG15.028/HU	7.50" ZnSe Plan.-con. - ULTRA LOW High pressure lens (19bar), 50.8mm Effective focal length: 190.5mm Edge thickness: 7.87mm AR/AR for 10.6µm (absorption <0.13%)	1pc

OD ON DEMAND – WE DO NOT KEEP THESE PARTS IN STOCK, COST IS SET ACCORDING TO THE ORDERED QUANTITY, DELIVERY TIME MAY DIFFER FROM STANDARD PRODUCTS.

Last update of this page: 22/08/2022. See Revision history for details.

THERMACUT®
THE CUTTING COMPANY®

WWW.THERMACUT.COM
TEL.: +420 556 423 440
SALES@THERMACUT.CZ

THERMACUT®, THE CUTTING COMPANY®, FHT-EX®, EX-TRAFIRE®, EX-TRACK®, EX-TRABEAM® AND EX-TRAFLEAME® ARE REGISTERED TRADEMARKS OF THERMACUT, K.S. AND MAY BE REGISTERED IN CZECH REPUBLIC AND/OR OTHER COUNTRIES. ALL OTHER TRADEMARKS ARE PROPERTIES OF THEIR RESPECTIVE OWNERS. THERMACUT® IS IN NO WAY AFFILIATED WITH AMADA®. MOST THERMACUT® PARTS ARE MADE FOR OR BY AN IBG COMPANY.
VALID FROM SEPTEMBER 2022 • PREVIOUS VERSION IS NO LONGER VALID. • © COPYRIGHT 2022 BY THERMACUT® CZECH REPUBLIC. ALL RIGHTS RESERVED.

THERMACUT® REPLACEMENT PARTS SUITABLE FOR AMADA®

LENSES SUITABLE FOR AMADA®



Part No.	Ref. No.	Description	Std. Pkg.	Part No.	Ref. No.	Description	Std. Pkg.
HG10.167/H	M78025	5.00" ZnSe Meniscus lens High pressure lens (29bar), 38.1mm Effective focal length: 127.0mm Edge thickness: 7.4mm AR/AR for 10.6µm (absorption <0.20%)	1pc	HG10.167/HU	M78025UL	5.00" ZnSe Men. lens - ULTRA LOW High pressure lens (29bar), 38.1mm Effective focal length: 127.0mm Edge thickness: 7.4mm AR/AR for 10.6µm (absorption <0.13%)	1pc
HG10.168/H	M78026	7.50" ZnSe Meniscus lens High pressure lens (29bar), 38.1mm Effective focal length: 190.5mm Edge thickness: 7.4mm AR/AR for 10.6µm (absorption <0.20%)	1pc	HG10.168/HU	M78026UL	7.50" ZnSe Men. lens - ULTRA LOW High pressure lens (29bar), 38.1mm Effective focal length: 190.5mm Edge thickness: 7.4mm AR/AR for 10.6µm (absorption <0.13%)	1pc
HG15.002/H	M78037	5.00" ZnSe Plano-convex lens High pressure lens (28bar), 50.8mm Effective focal length: 127.0mm Edge thickness: 9.7mm AR/AR for 10.6µm (absorption <0.20%)	1pc	HG15.002/HU	M78037UL	5.00" ZnSe Plan.-con. - ULTRA LOW High pressure lens (28bar), 50.8mm Effective focal length: 127.0mm Edge thickness: 9.7mm AR/AR for 10.6µm (absorption <0.13%)	1pc
HG15.003/H	M78038	7.50" ZnSe Plano-convex lens High pressure lens (28bar), 50.8mm Effective focal length: 190.5mm Edge thickness: 9.7mm AR/AR for 10.6µm (absorption <0.20%)	1pc	HG15.003/HU	M78038UL	7.50" ZnSe Plan.-con. - ULTRA LOW High pressure lens (28bar), 50.8mm Effective focal length: 190.5mm Edge thickness: 9.7mm AR/AR for 10.6µm (absorption <0.13%)	1pc
HG15.005/H	HG15.005/H	10.0" ZnSe Plano-convex lens High pressure lens (29bar), EZ-Mount TM, 50.8mm Effective focal length: 254mm Edge thickness: 9.6mm AR/AR for 10.6µm (absorption <0.20%)	1pc	HG15.015/HU	HG15.015/HU	5" ZnSe Plano-convex lens - ULTRA LOW High pressure lens (29bar), 38.1mm Effective focal length: 127.0mm Edge thickness: 7.6mm AR/AR for 10.6µm (absorption <0.13%)	1pc
HG15.015/H	HG15.015/H	5" ZnSe Plano-convex lens High pressure lens (29bar), 38.1mm Effective focal length: 127.0mm Edge thickness: 7.6mm AR/AR for 10.6µm (absorption <0.20%)	1pc	HG15.016/HU	HG15.016/HU	7.50" ZnSe Plano-convex lens - ULTRA LOW High pressure lens (29bar), 38.1mm Effective focal length: 190.5mm Edge thickness: 7.6mm AR/AR for 10.6µm (absorption <0.13%)	1pc
HG15.016/H	HG15.016/H	7.50" ZnSe Plano-convex lens High pressure lens (29bar), 38.1mm Effective focal length: 190.5mm Edge thickness: 7.8mm AR/AR for 10.6µm (absorption <0.20%)	1pc				

PROTECTION WINDOWS SUITABLE FOR AMADA®

Part No.	Ref. No.	Description	Std. Pkg.
HG17.521	HG17.521	Protection Window D33.00mm × ET = 1.50mm	1pc

ACCESSORIES SUITABLE FOR AMADA®

Part No.	Ref. No.	Description	Std. Pkg.
HG10.174	HG10.174	Polish for laser optics, 250ml, 0367432/2243066	1pc
HG10.173	HG10.173	Lens cleaning paper from TIFFEN®, sheet size 70 × 115mm	50pcs

OD ON DEMAND – WE DO NOT KEEP THESE PARTS IN STOCK, COST IS SET ACCORDING TO THE ORDERED QUANTITY, DELIVERY TIME MAY DIFFER FROM STANDARD PRODUCTS.

Last update of this page: 21/04/2022. See Revision history for details.

THERMACUT® REPLACEMENT PARTS SUITABLE FOR BYSTRONIC® BYSTRONIC® "BY" SERIES

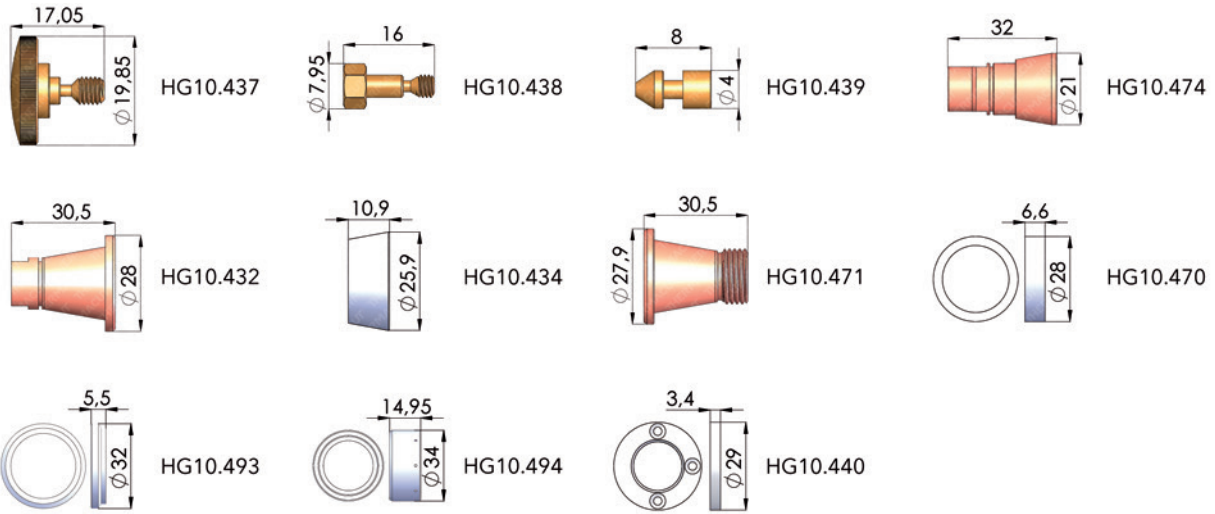

Part No.	Ref. No.	Description	Std. Pkg.	Part No.	Ref. No.	Description	Std. Pkg.
HG10.437	OD 4-03136	Knurled Screw	1pc	HG10.472	2-08700	Shield (copper)	1pc
HG10.438	OD 4-00324	Knurled Screw	1pc	HG10.493	3-13113	Insulating Ring (small)	1pc
HG10.439	4-03137	Pin	1pc	HG10.495	2-10837	Nozzle Body	1pc
HG10.474	OD 3-02291	Nozzle Body	1pc	HG10.488	10032930	Nozzle Body	1pc
HG10.433	4-01642	Insulating Ring - Ceramic	1pc	HG10.494	3-13422	Insulating Ring (large)	1pc
HG10.432	3-05497	Nozzle Body	1pc	HG10.440	3-06035	Insulating Disc (PTFE)	1pc
HG10.434	4-01959	Conical Ceramic	1pc	HG10.496	10055576	Nozzle Holder BySprint™	1pc
HG10.471	2-08701	Nozzle Body	1pc	HG10.497	10051133	Nozzle Holder BySprint™	1pc
HG10.473	3-11071	Fastener Nut	1pc				
HG10.470	4-09010	Ceramic	1pc				

PARTS SUITABLE FOR BYSTRONIC® "BY" SERIES

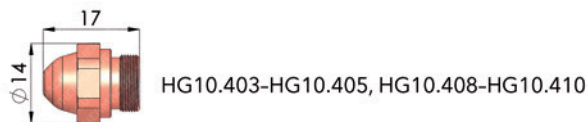

Part No.	Ref. No.	Description	Std. Pkg.	Part No.	Ref. No.	Description	Std. Pkg.
HG10.403	3-01894	Nozzle 1.0mm - 10	10pcs	HG10.411	3-01902	Nozzle 1.75mm - H17	10pcs
HG10.404	3-01895	Nozzle 1.25mm - 12	10pcs	HG10.412	3-01903	Nozzle 2.0mm - H20	10pcs
HG10.405	3-01896	Nozzle 1.50mm - 15	10pcs	HG10.413	3-01905	Nozzle 1.0mm - K10	10pcs
HG10.408	3-01899	Nozzle 1.00mm - H10	10pcs	HG10.414	OD 3-01906	Nozzle 1.25mm - K12	10pcs
HG10.409	3-01900	Nozzle 1.25mm - H12	10pcs	HG10.415	3-01907	Nozzle 1.50mm - K15	10pcs
HG10.410	3-01901	Nozzle 1.50mm - H15	10pcs				

OD ON DEMAND – WE DO NOT KEEP THESE PARTS IN STOCK, COST IS SET ACCORDING TO THE ORDERED QUANTITY, DELIVERY TIME MAY DIFFER FROM STANDARD PRODUCTS.

PolyTetraFluoroEthylene is a fluorocarbon-based polymer and is commonly abbreviated PTFE. The Teflon® brand of PTFE is manufactured only by DuPont® and is not sold by THERMACUT®. THERMACUT® purchases other brands of PTFE from various high quality manufacturers.

Last update of this page: 27/06/2022. See Revision history for details.

THERMACUT®
THE CUTTING COMPANY®

WWW.THERMACUT.COM
TEL.: +420 556 423 440
SALES@THERMACUT.CZ

THERMACUT®, THE CUTTING COMPANY®, FHT-EX®, EX-TRAFIRE®, EX-TRACK®, EX-TRABEAM® AND EX-TRAFLEAME® ARE REGISTERED TRADEMARKS OF THERMACUT, K.S. AND MAY BE REGISTERED IN CZECH REPUBLIC AND/OR OTHER COUNTRIES. ALL OTHER TRADEMARKS ARE PROPERTIES OF THEIR RESPECTIVE OWNERS. THERMACUT® IS IN NO WAY AFFILIATED WITH BYSTRONIC® AND E.I. DU PONT DE NEMOURS AND COMPANY. MOST THERMACUT® PARTS ARE MADE FOR OR BY AN IBG COMPANY.
VALID FROM SEPTEMBER 2022 • PREVIOUS VERSION IS NO LONGER VALID. • © COPYRIGHT 2022 BY THERMACUT® CZECH REPUBLIC. ALL RIGHTS RESERVED.

THERMACUT® REPLACEMENT PARTS SUITABLE FOR BYSTRONIC® BYSTRONIC® "BY" SERIES

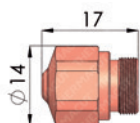

HG10.416-HG10.421
HG10.426

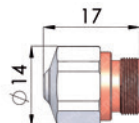

HG10.418/C
HG10.419/C
HG10.420/C

Standard copper nozzles / Standard copper nozzles with hard chromium plating

Part No.	Ref. No.	Description	Std. Pkg.	Part No.	Ref. No.	Description	Std. Pkg.
HG10.416	3-01908	Nozzle 1.75mm - K17	10pcs	HG10.420/C	3-01912CP	Nozzle 1.50mm - HK15 - HCP	10pcs
HG10.417	OD 3-01909	Nozzle 2.00mm - K20	10pcs	HG10.421	3-01913	Nozzle 1.75mm - HK17	10pcs
HG10.426	OD 3-04274	Nozzle 2.25mm - K25	10pcs	HG10.421/C	3-01913CP	Nozzle 1.75mm - HK17 - HCP	10pcs
HG10.418	3-01910	Nozzle 1.00mm - HK10	10pcs	HG10.422	3-01914	Nozzle 2.0mm - HK20	10pcs
HG10.418/C	3-01910CP	Nozzle 1.00mm - HK10 - HCP	10pcs	HG10.422/C	3-01914CP	Nozzle 2.0mm - HK20 - HCP	10pcs
HG10.419	3-01911	Nozzle 1.25mm - HK12	10pcs	HG10.423	3-03854	Nozzle 2.5mm - HK25	10pcs
HG10.419/C	3-01911CP	Nozzle 1.25mm - HK12 - HCP	10pcs	HG10.425	3-06112	Nozzle 3.0mm - HK30	10pcs
HG10.420	3-01912	Nozzle 1.50mm - HK15	10pcs	HG10.424	HG10.424	Nozzle 3.50mm - HK35	10pcs

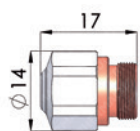

HG10.428/D
HG10.429/D
HG10.431/D-HG10.434/D

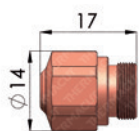

HG10.430/D
HG10.433/A
HG10.435/D
HG10.435/A

Standard double copper nozzles / Standard double copper nozzles with hard chromium plating

Part No.	Ref. No.	Description	Std. Pkg.	Part No.	Ref. No.	Description	Std. Pkg.
HG10.428/D	3-16058	Nozzle 1.00mm - NK10	10pcs	HG10.418/D	3-16058CP	Nozzle 1.00mm - NK10 - HCP	10pcs
HG10.429/D	3-16059	Nozzle 1.20mm - NK12	10pcs	HG10.419/D	3-16059CP	Nozzle 1.20mm - NK12 - HCP	10pcs
HG10.430/D	3-16060	Nozzle 1.50mm - NK15	10pcs	HG10.420/D	3-16060CP	Nozzle 1.50mm - NK15 - HCP	10pcs
HG10.431/D	3-14317	Nozzle 1.70mm - NK17	10pcs	HG10.421/D	3-14317CP	Nozzle 1.70mm - NK17 - HCP	10pcs
HG10.432/D	3-14318	Nozzle 2.00mm - NK20	10pcs	HG10.423/D	3-14319CP	Nozzle 2.50mm - NK25 - HCP	10pcs
HG10.433/D	3-14319	Nozzle 2.50mm - NK25	10pcs	HG10.423/A OD	3-16256CP	Nozzle 2.50mm - NK25 - AL - HCP	10pcs
HG10.433/A	3-16256	Nozzle 2.50mm - NK25 - AL	10pcs	HG10.425/D	3-16061CP	Nozzle 3.00mm - NK30 - HCP	10pcs
HG10.435/D	3-16061	Nozzle 3.00mm - NK30	10pcs	HG10.425/A	3-16257CP	Nozzle 3.00mm - NK30 - AL - HCP	10pcs
HG10.435/A	3-16257	Nozzle 3.00mm - NK30 - AL	10pcs	HG10.424/D	HG10.434DCP	Nozzle 3.50mm - NK35 - HCP	10pcs
HG10.434/D	HG10.434D	Nozzle 3.50mm - NK35	10pcs				

OD ON DEMAND – WE DO NOT KEEP THESE PARTS IN STOCK, COST IS SET ACCORDING TO THE ORDERED QUANTITY, DELIVERY TIME MAY DIFFER FROM STANDARD PRODUCTS.

Last update of this page: 27/06/2022. See Revision history for details.

THERMACUT®
THE CUTTING COMPANY®

WWW.THERMACUT.COM
TEL.: +420 556 423 440
SALES@THERMACUT.CZ

THERMACUT®, THE CUTTING COMPANY®, FHT-EX®, EX-TRAFIRE®, EX-TRACK®, EX-TRABEAM® AND EX-TRAFLEAME® ARE REGISTERED TRADEMARKS OF THERMACUT, K.S. AND MAY BE REGISTERED IN CZECH REPUBLIC AND/OR OTHER COUNTRIES. ALL OTHER TRADEMARKS ARE PROPERTIES OF THEIR RESPECTIVE OWNERS. THERMACUT® IS NO WAY AFFILIATED WITH BYSTRONIC®. MOST THERMACUT® PARTS ARE MADE FOR OR BY AN IBG COMPANY.
VALID FROM SEPTEMBER 2022 • PREVIOUS VERSION IS NO LONGER VALID. • © COPYRIGHT 2022 BY THERMACUT® CZECH REPUBLIC. ALL RIGHTS RESERVED.

THERMACUT® REPLACEMENT PARTS SUITABLE FOR BYSTRONIC® LENSES SUITABLE FOR BYSTRONIC®



Part No.	Ref. No.	Description	Std. Pkg.	Part No.	Ref. No.	Description	Std. Pkg.
HG10.731/H	4-00186	5.00" ZnSe Meniscus lens High pressure lens (20bar), 38.1mm Effective focal length: 127.0mm Edge thickness: 6.0mm AR/AR for 10.6µm (absorption <0.20%)	1pc	HG10.733/H	4-05094	5.00" ZnSe Meniscus lens High pressure lens (42bar), 38.1mm Effective focal length: 127.0mm Edge thickness: 9.0mm AR/AR for 10.6µm (absorption <0.20%)	1pc
HG10.732/H	4-00187	7.50" ZnSe Meniscus lens High pressure lens (20bar), 38.1mm Effective focal length: 190.5mm Edge thickness: 6.0mm AR/AR for 10.6µm (absorption <0.20%)	1pc	HG10.734/H	4-05095	7.50" ZnSe Meniscus lens High pressure lens (42bar), 38.1mm Effective focal length: 190.5mm Edge thickness: 9.0mm AR/AR for 10.6µm (absorption <0.20%)	1pc
HG10.729/H	4-10736	3.75" ZnSe Meniscus lens High pressure lens (42bar), 38.1mm Effective focal length: 95.3mm Edge thickness: 9.0mm AR/AR for 10.6µm (absorption <0.20%)	1pc	HG10.733/HU	4-07475	5.00" ZnSe Meniscus lens - ULTRA LOW High pressure lens (42bar), 38.1mm Effective focal length: 127.0mm Edge thickness: 9.0mm AR/AR for 10.6µm (absorption <0.13%)	1pc
				HG10.734/HU	4-07476	7.50" ZnSe Meniscus lens - ULTRA LOW High pressure lens (42bar), 38.1mm Effective focal length: 190.5mm Edge thickness: 9.0mm AR/AR for 10.6µm (absorption <0.13%)	1pc

PROTECTION WINDOWS SUITABLE FOR BYSTRONIC®

Part No.	Ref. No.	Description	Std. Pkg.
HG17.517	10045746	Protection Window D36.00mm × ET = 5.0mm	1pc

ACCESSORIES SUITABLE FOR BYSTRONIC®

Part No.	Ref. No.	Description	Std. Pkg.
HG10.174	HG10.174	Polish for laser optics, 250ml, 0367432/2243066	1pc
HG10.173	HG10.173	Lens cleaning paper from TIFFEN®, sheet size 70 × 115mm	50pcs
HG15.136	OD HG15.136	Latex gloves	100pcs

AIR FILTERS SUITABLE FOR BYSTRONIC®

Part No.	Ref. No.	Description	Std. Pkg.	Part No.	Ref. No.	Description	Std. Pkg.
HG10.176	OD HG10.176	Air filter for cooling aggregate size: 800 × 600 × 8mm	25pcs	HG11.176	OD HG11.176	Air filter for cooling aggregate size: 1050 × 1050 × 8mm	25pcs
HG11.179	OD HG11.179	Air filter for cooling aggregate size: 600 × 1200 × 8mm	25pcs				

OD ON DEMAND – WE DO NOT KEEP THESE PARTS IN STOCK, COST IS SET ACCORDING TO THE ORDERED QUANTITY, DELIVERY TIME MAY DIFFER FROM STANDARD PRODUCTS.

Last update of this page: 21/04/2022. See Revision history for details.

THERMACUT® REPLACEMENT PARTS SUITABLE FOR CINCINNATI®

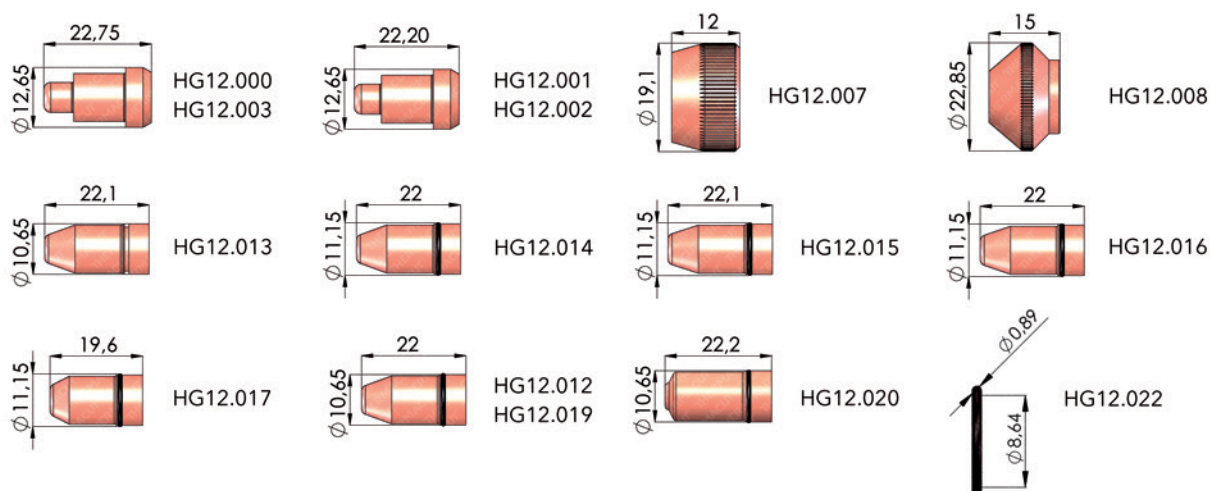

Part No.	Ref. No.	Description	Std. Pkg.	Part No.	Ref. No.	Description	Std. Pkg.
HG12.000	OD 908090	Nozzle 1.5mm (0.060")	10pcs	HG12.016	924634	Nozzle 3.0mm (0.120")	10pcs
HG12.001	OD 907469	Nozzle 1.0mm (0.040")	10pcs	HG12.017	OD 924635	Nozzle 3.15mm (0.124")	10pcs
HG12.002	OD 907470	Nozzle 1.5mm (0.060")	10pcs	HG12.018	OD 923013	Nozzle 1.0mm (0.040")	10pcs
HG12.003	OD 920006	Nozzle 2.0mm (0.080")	10pcs	HG12.019	923014	Nozzle 1.5mm (0.060")	10pcs
HG12.007	OD 909659	Tip Lock Nut	1pc	HG12.020	924636	Nozzle 1.5mm (0.060")	10pcs
HG12.008	OD 963021	Tip Retainer Nut	1pc	HG12.021	924637	Nozzle 2.0mm (0.080")	10pcs
HG12.012	OD 924635-1	Nozzle 1.0mm (0.040")	10pcs	HG12.022	OD 909680	O-Ring Kit for Nozzle (10pcs)	1pc
HG12.013	909660	Nozzle 1.5mm (0.060")	10pcs	HG12.041	PLGJT0256	Nozzle Double Blunt 1	10pcs
HG12.014	OD 910315	Nozzle 2.0mm (0.080")	10pcs	HG12.042	PLGJT0257	Nozzle Double Blunt 1.5	10pcs
HG12.015	924638	Nozzle 2.5mm (0.100")	10pcs	HG12.040	PLGJT0718	Nozzle Double Blunt 1.5-2.0	10pcs

PROTECTION WINDOWS SUITABLE FOR CINCINNATI®

Part No.	Ref. No.	Description	Std. Pkg.
HG12.036	HG12.036	Protection Window D38.10mm × ET = 1.60mm	1pc
HG12.037	HG12.037	Protection Window D38.10mm × ET = 6.0mm	1pc

OD ON DEMAND – WE DO NOT KEEP THESE PARTS IN STOCK, COST IS SET ACCORDING TO THE ORDERED QUANTITY, DELIVERY TIME MAY DIFFER FROM STANDARD PRODUCTS.

Last update of this page: 08/02/2022. See Revision history for details.

THERMACUT®
THE CUTTING COMPANY®

WWW.THERMACUT.COM
TEL.: +420 556 423 440
SALES@THERMACUT.CZ

THERMACUT®, THE CUTTING COMPANY®, FHT-EX®, EX-TRAFIRE®, EX-TRACK®, EX-TRABEAM® AND EX-TRAFLEAME® ARE REGISTERED TRADEMARKS OF THERMACUT, K.S. AND MAY BE REGISTERED IN CZECH REPUBLIC AND/OR OTHER COUNTRIES. ALL OTHER TRADEMARKS ARE PROPERTIES OF THEIR RESPECTIVE OWNERS. THERMACUT® IS IN NO WAY AFFILIATED WITH CINCINNATI®. MOST THERMACUT® PARTS ARE MADE FOR OR BY AN IBG COMPANY.
VALID FROM SEPTEMBER 2022 • PREVIOUS VERSION IS NO LONGER VALID. • © COPYRIGHT 2022 BY THERMACUT® CZECH REPUBLIC. ALL RIGHTS RESERVED.

THERMACUT® REPLACEMENT PARTS SUITABLE FOR MAZAK®

MAZAK® XT510 HI-PRO™, NTX48™, TURBO 10KW™, SUPER TURBO 15KW™, SUPER TURBO 20KW HI-PRO™, SUPER TURBO X510 HI-PRO™

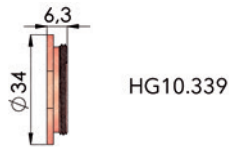

HG10.339

Part No.	Ref. No.	Description	Std. Pkg.	Part No.	Ref. No.	Description	Std. Pkg.
HG10.339	46683301100	Bracket	1pc	HG10.353	HG10.353	Complete Nozzle Holder	1pc
HG10.347	46683301160	Ring	1pc				

SUITABLE FOR

MAZAK® LASER CNC L32 PLUS SUPER CHARGE™, XT510™, NTX48™, TURBO 10KW™, SUPER TURBO 15KW™, SUPER TURBO 20KW HI-PRO™, SUPER TURBO X510 HI-PRO™

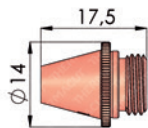

HG10.309
HG10.310
HG10.318

Adapter copper nozzles

Part No.	Ref. No.	Description	Std. Pkg.	Part No.	Ref. No.	Description	Std. Pkg.
HG10.309	46603350512K	Adapter Nozzle 1.2mm	10pcs	HG10.477	46603350512H	Adapter-6-edgenozzle 1.2mm	10pcs
HG10.310	46603350515K	Adapter Nozzle 1.5mm	10pcs				
HG10.318	46603350520K	Adapter Nozzle 2.0mm	10pcs				
HG10.308	46603350525K	Adapter Nozzle 2.5mm	10pcs				

SUITABLE FOR

MAZAK® 5" C/MG, MAZAK® 5" H/MG

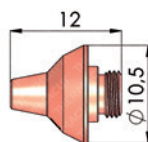

HG10.287-HG10.290
HG10.487

Part No.	Ref. No.	Description	Std. Pkg.	Part No.	Ref. No.	Description	Std. Pkg.
HG10.287	46713300290-12	Nozzle 1.2mm 3D (P0352-384-00012)	1pc	HG10.295	46713300300	Nozzle 2.0mm 2D (P0352-387-00020)	1pc
HG10.288	46713300290-15	Nozzle 1.5mm 3D (P0352-381-00015)	1pc	HG10.296	46713300300-25	Nozzle 2.5mm 2D	1pc
HG10.290	46713300310-2.0	Nozzle 2.0mm 3D (P0352-382-00020)	1pc	HG10.297	46713300300-30	Nozzle 3.0mm 2D	1pc
HG10.487	46713300280-30	Nozzle 3.0mm 3D	1pc				

Last update of this page: 27/06/2022. See Revision history for details.

THERMACUT®
THE CUTTING COMPANY®

WWW.THERMACUT.COM
TEL.: +420 556 423 440
SALES@THERMACUT.CZ

THERMACUT®, THE CUTTING COMPANY®, FHT-EX®, EX-TRAFIRE®, EX-TRACK®, EX-TRABEAM® AND EX-TRAFLEAME® ARE REGISTERED TRADEMARKS OF THERMACUT, K.S. AND MAY BE REGISTERED IN CZECH REPUBLIC AND/OR OTHER COUNTRIES. ALL OTHER TRADEMARKS ARE PROPERTIES OF THEIR RESPECTIVE OWNERS. THERMACUT® IS IN NO WAY AFFILIATED WITH MAZAK®. MOST THERMACUT® PARTS ARE MADE FOR OR BY AN IBG COMPANY.
VALID FROM SEPTEMBER 2022 • PREVIOUS VERSION IS NO LONGER VALID. • © COPYRIGHT 2022 BY THERMACUT® CZECH REPUBLIC. ALL RIGHTS RESERVED.

THERMACUT® REPLACEMENT PARTS SUITABLE FOR MAZAK® SUITABLE FOR HYPER GEAR NTX510™

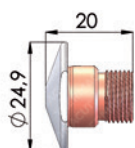

HG10.670-HG10.673

Part No.	Ref. No.	Description	Std. Pkg.	Part No.	Ref. No.	Description	Std. Pkg.
HG10.670	46143304470	Nozzle 1.2mm HCP	10pcs	HG10.672	46143304460	Nozzle 2.0mm HCP	10pcs
HG10.671	46143304450	Nozzle 1.5mm HCP	10pcs	HG10.673	46143304480	Nozzle 2.5mm HCP	10pcs

THERMACUT® REPLACEMENT PARTS SUITABLE FOR MAZAK®

Part No.	Ref. No.	Description	Std. Pkg.	Part No.	Ref. No.	Description	Std. Pkg.
HG10.629	36143304420	Nozzle Holder Hyper Gear	1pc	HG10.643 OD	46683301180	Screw	1pc
HG10.630	36143304400	Coupler	1pc	HG10.644	46143304440	Insulator - PTFE	1pc
HG10.632	46143304430	Spring Retainer	1pc	HG10.645	46143300290	Retainer Nut	1pc
HG10.633	46143308000	Spring Retainer - Steel	1pc	HG10.646 OD	46143300260	Insulator - PTFE	1pc
HG10.634	46143300220	Spring	1pc	HG10.647 OD	46143300270	Insulator - PTFE	1pc
HG10.635	36143303242	Body	1pc	HG10.648	46143300280	Retainer Nut	1pc
HG10.636	36143307980	Aluminium Body	1pc	HG10.649	46143300320	Ring - Brass	1pc
HG10.638	46143308170	Spacer	1pc	HG10.667	36143300332	Ring - Aluminum	1pc
HG10.639 OD	46143308190	Connector	1pc	HG10.686		Complete Head (PTFE Spacer)	1pc
HG10.640	46143300240	Insulator - PTFE	1pc	HG10.687		Complete Head (PTFE Spacer)	1pc
HG10.641	46143304250	Retainer Nut	1pc				
HG10.642 OD	46143307420	Retainer Nut	1pc				

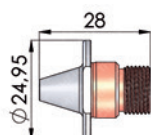

HG10.691-HG10.697

Part No.	Ref. No.	Description	Std. Pkg.	Part No.	Ref. No.	Description	Std. Pkg.
HG10.691	46143310341	Nozzle 1.2mm Slim CP	10pcs	HG10.697	46143310381	Nozzle 3.0mm Slim CP	10pcs
HG10.692	46143310351	Nozzle 1.5mm Slim CP	10pcs				
HG10.694	46143310361	Nozzle 2.0mm Slim CP	10pcs				
HG10.696	46143310371	Nozzle 2.5mm Slim CP	10pcs				

OD ON DEMAND – WE DO NOT KEEP THESE PARTS IN STOCK, COST IS SET ACCORDING TO THE ORDERED QUANTITY, DELIVERY TIME MAY DIFFER FROM STANDARD PRODUCTS.

PolyTetraFluoroEthylene is a fluorocarbon-based polymer and is commonly abbreviated PTFE. The Teflon® brand of PTFE is manufactured only by DuPont® and is not sold by THERMACUT®. THERMACUT® purchases other brands of PTFE from various high quality manufacturers.

Last update of this page: 27/06/2022. See Revision history for details.

THERMACUT®
THE CUTTING COMPANY®

WWW.THERMACUT.COM
TEL.: +420 556 423 440
SALES@THERMACUT.CZ

THERMACUT®, THE CUTTING COMPANY®, FHT-EX®, EX-TRAFIRE®, EX-TRACK®, EX-TRABEAM® AND EX-TRAFLEAME® ARE REGISTERED TRADEMARKS OF THERMACUT, K.S. AND MAY BE REGISTERED IN CZECH REPUBLIC AND/OR OTHER COUNTRIES. ALL OTHER TRADEMARKS ARE PROPERTIES OF THEIR RESPECTIVE OWNERS. THERMACUT® IS IN NO WAY AFFILIATED WITH MAZAK® AND E.I. DU PONT DE NEMOURS AND COMPANY. MOST THERMACUT® PARTS ARE MADE FOR OR BY AN IBG COMPANY.
VALID FROM SEPTEMBER 2022 • PREVIOUS VERSION IS NO LONGER VALID. • © COPYRIGHT 2022 BY THERMACUT® CZECH REPUBLIC. ALL RIGHTS RESERVED.

THERMACUT® REPLACEMENT PARTS SUITABLE FOR MAZAK®

LENSES SUITABLE FOR MAZAK®



Part No.	Ref. No.	Description	Std. Pkg.	Part No.	Ref. No.	Description	Std. Pkg.
HG10.167/H	HG10.167/H	5.00" ZnSe Meniscus lens High pressure lens (29bar), 38.1mm Effective focal length: 127.0mm Edge thickness: 7.4mm AR/AR for 10.6µm (absorption <0.20%)	1pc	HG15.016/H	HG15.016/H	7.50" ZnSe Plano-convex lens High pressure lens (29bar), 38.1mm Effective focal length: 190.5mm Edge thickness: 7.6mm AR/AR for 10.6µm (absorption <0.20%)	1pc
HG10.620/H OD	HG10.620/H	5.00" ZnSe Meniscus lens High pressure lens (28bar), 50.8mm Effective focal length: 127.0mm Edge thickness: 9.7mm AR/AR for 10.6µm (absorption <0.20%)	1pc	HG10.621/H	HG10.621/H	7.50" ZnSe Meniscus lens High pressure lens (28bar), 50.8mm Effective focal length: 190.5mm Edge thickness: 9.7mm AR/AR for 10.6µm (absorption <0.20%)	1pc
HG15.015/H	HG15.015/H	5.00" ZnSe Plano-convex lens High pressure lens (28bar), 38.1mm Effective focal length: 127.0mm Edge thickness: 7.6mm AR/AR for 10.6µm (absorption <0.20%)	1pc	HG15.028/H	HG15.028/H	7.50" ZnSe Plano-convex lens High pressure lens (19bar), 50.8mm Effective focal length: 190.5mm Edge thickness: 7.87mm AR/AR for 10.6µm (absorption <0.20%)	1pc
HG15.024/H OD	HG15.024/H	5.00" ZnSe Plano-convex lens High pressure lens (33bar), 38.1mm Effective focal length: 127.0mm Edge thickness: 7.87mm AR/AR for 10.6µm (absorption <0.20%)	1pc	HG15.003/H	HG15.003/H	7.50" ZnSe Plano-convex lens High pressure lens (28bar), 50.8mm Effective focal length: 190.5mm Edge thickness: 9.7mm AR/AR for 10.6µm (absorption <0.20%)	1pc
HG15.029/H OD	HG15.029/H	5.00" ZnSe Plano-convex lens High pressure lens (19bar), 50.8mm Effective focal length: 127.0mm Edge thickness: 7.87mm AR/AR for 10.6µm (absorption <0.20%)	1pc	HG10.167/HU	HG10.167/HU	5.00" ZnSe Men. lens - ULTRA LOW High pressure lens (29bar), 38.1mm Effective focal length: 127.0mm Edge thickness: 7.4mm AR/AR for 10.6µm (absorption <0.13%)	1pc
HG15.002/H	HG15.002/H	5.00" ZnSe Plano-convex lens High pressure lens (28bar), 50.8mm Effective focal length: 127.0mm Edge thickness: 9.7mm AR/AR for 10.6µm (absorption <0.20%)	1pc	HG10.168/HU	HG10.168/HU	7.50" ZnSe Men. lens - ULTRA LOW High pressure lens (29bar), 38.1mm Effective focal length: 190.5mm Edge thickness: 7.4mm AR/AR for 10.6µm (absorption <0.13%)	1pc
HG10.168/H	HG10.168/H	7.50" ZnSe Meniscus lens High pressure lens (29bar), 38.1mm Effective focal length: 190.5mm Edge thickness: 7.4mm AR/AR for 10.6µm (absorption <0.20%)	1pc				

ACCESSORIES SUITABLE FOR MAZAK®

Part No.	Ref. No.	Description	Std. Pkg.
HG10.174	HG10.174	Polish for laser optics, 250ml, 0367432/2243066	1pc
HG10.173	HG10.173	Lens cleaning paper from TIFFEN®, sheet size 70 × 115mm	50pcs

OD ON DEMAND – WE DO NOT KEEP THESE PARTS IN STOCK, COST IS SET ACCORDING TO THE ORDERED QUANTITY, DELIVERY TIME MAY DIFFER FROM STANDARD PRODUCTS.

Last update of this page: 21/04/2022. See Revision history for details.

THERMACUT®
THE CUTTING COMPANY®

WWW.THERMACUT.COM
TEL.: +420 556 423 440
SALES@THERMACUT.CZ

THERMACUT®, THE CUTTING COMPANY®, FHT-EX®, EX-TRAFIRE®, EX-TRACK®, EX-TRABEAM® AND EX-TRAFLEAME® ARE REGISTERED TRADEMARKS OF THERMACUT, K.S. AND MAY BE REGISTERED IN CZECH REPUBLIC AND/OR OTHER COUNTRIES. ALL OTHER TRADEMARKS ARE PROPERTIES OF THEIR RESPECTIVE OWNERS. THERMACUT® IS IN NO WAY AFFILIATED WITH MAZAK® AND THE TIFFEN COMPANY. MOST THERMACUT® PARTS ARE MADE FOR OR BY AN IBG COMPANY.
VALID FROM SEPTEMBER 2022 • PREVIOUS VERSION IS NO LONGER VALID. • © COPYRIGHT 2022 BY THERMACUT® CZECH REPUBLIC. ALL RIGHTS RESERVED.

FOR US MARKET ONLY

THERMACUT® REPLACEMENT PARTS SUITABLE FOR MAZAK®

MAZAK® LASER CNC L32 PLUS SUPER CHARGE™, XT510™, NTX48™, TURBO 10KW™, SUPER TURBO 15KW™, SUPER TURBO 20KW HI-PRO™, SUPER TURBO X510 HI-PRO™

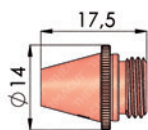

HG10.309
HG10.310
HG10.318

Adapter copper nozzles

Part No.	Ref. No.	Description	Std. Pkg.	Part No.	Ref. No.	Description	Std. Pkg.
HG10.309	46603350512K	Adapter Nozzle 1.2mm	10pcs	HG10.477-LS	46603350512H	Adapter-6-edgenozzle 1.2mm	10pcs
HG10.310	46603350515K	Adapter Nozzle 1.5mm	10pcs	HG10.479-LS	46603350517H	Adapter-6-edgenozzle 1.7mm	10pcs
HG10.318	46603350520K	Adapter Nozzle 2.0mm	10pcs	HG10.481-LS	46603350525H	Adapter-6-edgenozzle 2.5mm	10pcs
HG10.308	46603350525K	Adapter Nozzle 2.5mm	10pcs	HG10.482-LS	46603350530H	Adapter-6-edgenozzle 3.0mm	10pcs
HG10.475-LS	46603350508H	Adapter-6-edgenozzle 0.8mm	10pcs				
HG10.476-LS	46603350511H	Adapter-6-edgenozzle 1.0mm	10pcs				

Last update of this page: 27/06/2022. See Revision history for details.

THERMACUT®
THE CUTTING COMPANY®

WWW.THERMACUT.COM
TEL.: +420 556 423 440
SALES@THERMACUT.CZ

THERMACUT®, THE CUTTING COMPANY®, FHT-EX®, EX-TRAFIRE®, EX-TRACK®, EX-TRABEAM® AND EX-TRAFLEAME® ARE REGISTERED TRADEMARKS OF THERMACUT, K.S. AND MAY BE REGISTERED IN CZECH REPUBLIC AND/OR OTHER COUNTRIES. ALL OTHER TRADEMARKS ARE PROPERTIES OF THEIR RESPECTIVE OWNERS. THERMACUT® IS IN NO WAY AFFILIATED WITH MAZAK®. MOST THERMACUT® PARTS ARE MADE FOR OR BY AN IBG COMPANY.
VALID FROM SEPTEMBER 2022 • PREVIOUS VERSION IS NO LONGER VALID. • © COPYRIGHT 2022 BY THERMACUT® CZECH REPUBLIC. ALL RIGHTS RESERVED.

FOR US MARKET ONLY
THERMACUT® REPLACEMENT PARTS SUITABLE FOR
MAZAK®
MAZAK® 5" C/MG, MAZAK® 5" H/MG

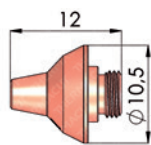

HG10.287-HG10.290
 HG10.487

Part No.	Ref. No.	Description	Std. Pkg.	Part No.	Ref. No.	Description	Std. Pkg.
HG10.287	46713300290-12	Nozzle 1.2mm 3D (P0352-384-00012)	1pc	HG10.295	46713300300	Nozzle 2.0mm 2D (P0352-387-00020)	1pc
HG10.288	46713300290-15	Nozzle 1.5mm 3D (P0352-381-00015)	1pc	HG10.296	46713300300-25	Nozzle 2.5mm 2D	1pc
HG10.290	46713300310-2.0	Nozzle 2.0mm 3D (P0352-382-00020)	1pc	HG10.297	46713300300-30	Nozzle 3.0mm 2D	1pc
HG10.486-LS	46713300280-25	Nozzle 2.5mm 3D (P0352-385-00025)	1pc	HG13.238-LS	36143312220	Nozzle Pencil 1.2CP	1pc
HG10.487-LS	46713300280-30	Nozzle 3.0mm 3D	1pc	HG13.240-LS	Q6143300060	Nozzle pencil 1.8CP	1pc
HG10.263-LS	46713300290-18	Nozzle 1.8mm 3D	1pc	HG13.241-LS	36143312240	Nozzle Pencil 2.0CP	1pc
HG10.264-LS	46713300280-20	Nozzle 2.0mm 3D	1pc	HG13.243-LS	36143312260	Nozzle Pencil 3.0CP	1pc
HG10.265-LS	46713300280-35	Nozzle 3.5mm 3D	1pc	HG13.244-LS	36143312270	Nozzle Pencil 3.5CP	1pc
HG13.246-LS	06143355590	Nozzle Pencil 4.5CP	1pc	HG13.245-LS	36143312280	Nozzle Pencil 4.0CP	1pc
HG10.292-LS	46713300310-1.2	Nozzle 1.2mm 2D	1pc				

FOR US MARKET ONLY
SUITABLE FOR HYPER GEAR NTX510™

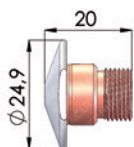

HG10.670-HG10.673

Part No.	Ref. No.	Description	Std. Pkg.	Part No.	Ref. No.	Description	Std. Pkg.
HG10.670	46143304470	Nozzle 1.2mm HCP	10pcs	HG13.202-LS	46603350530 4.0	Nozzle 4.0mm	10pcs
HG10.671-LS	46143304450	Nozzle 1.5mm HCP	10pcs	HG13.203-LS	46603350530 4.5	Nozzle 4.5mm	10pcs
HG10.672	46143304460	Nozzle 2.0mm HCP	10pcs	HG13.204-LS	46603350530-5.0	Nozzle 5.0mm	10pcs
HG10.673-LS	46143304480	Nozzle 2.5mm HCP	10pcs	HG13.248-LS	Q6143300080	Double Nozzle Pencil 1.2CP	10pcs
HG10.674-LS	46143304490	Nozzle 3.0mm HCP	10pcs	HG13.249-LS	36143312300	Double Nozzle Pencil 1.5CP	10pcs
HG10.675-LS	46143304500	Nozzle 3.5mm HCP	10pcs	HG10.286-LS	46713300290-10	Nozzle 1.0mm 3D	10pcs
HG10.676-LS	46143304510	Nozzle 4.0mm HCP	10pcs	HG13.206-LS	Q6713330410	Nozzle 1.2mm 3D	10pcs
HG13.201-LS	46603350530 -3.5	Nozzle 3.5mm	10pcs				

Last update of this page: 27/06/2022. See Revision history for details.

FOR US MARKET ONLY

THERMACUT® REPLACEMENT PARTS SUITABLE FOR MAZAK®

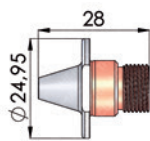

HG10.691–HG10.697

Part No.	Ref. No.	Description	Std. Pkg.	Part No.	Ref. No.	Description	Std. Pkg.
HG10.691	46143310341	Nozzle 1.2mm Slim CP	10pcs	HG10.708-LS	46603350520-1.5	Nozzle 1.5mm	10pcs
HG10.692	46143310351	Nozzle 1.5mm Slim CP	10pcs	HG10.709-LS	46603350521-1.7	Nozzle 1.7mm	10pcs
HG10.694	46143310361	Nozzle 2.0mm Slim CP	10pcs	HG10.710-LS	46603350522-2.0	Nozzle 2.0mm	10pcs
HG10.696	46143310371	Nozzle 2.5mm Slim CP	10pcs	HG10.711-LS	46603350522-2.5	Nozzle 2.5mm	10pcs
HG10.697	46143310381	Nozzle 3.0mm Slim CP	10pcs	HG13.262-LS	4660335052C	Nozzle 2.0 CP	10pcs
HG13.223-LS	46143310373	Nozzle Slim 2.5CP	10pcs	HG13.200-LS	4660335052B	Nozzle 1.5	10pcs
HG13.222-LS	46143310363	Nozzle Slim 2.0CP	10pcs	HG13.236-LS	06283301190	Nozzle Pencil 1.0CP	10pcs
HG13.225-LS	46143310403	Nozzle Slim 4.0CP	10pcs	HG13.239-LS	36143312230	Nozzle Pencil 1.5CP	10pcs
HG13.224-LS	46143310393	Nozzle Slim 3.5CP	10pcs	HG13.242-LS	36143312250	Nozzle Pencil 2.5CP	10pcs
HG13.247-LS	06143355600	Nozzle Pencil 5.5CP	10pcs	HG13.237-LS	06283301030	Nozzle Pencil 5.0CP	10pcs
HG13.207-LS	46683302420	Double Nozzle 1.5	10pcs	HG13.258-LS	6283301790	Nozzle Pencil 1.0/ HP CP	10pcs
HG13.218-LS	46143306450	Double Nozzle 1.5CP	10pcs	HG13.259-LS	6283301800	Nozzle Pencil 1.2/ HP CP	10pcs
HG13.211-LS	46683302420	Double Nozzle 1.5CP	10pcs	HG13.260-LS	6283301810	Nozzle Pencil 1.5/ HP CP	10pcs
HG13.208-LS	46683302430	Double Nozzle 2.0	10pcs	HG13.261-LS	6283301820	Double Nozzle Pencil 1.0/ HP CP	10pcs
HG13.219-LS	46143306460	Double Nozzle 2.0CP	10pcs	HG13.250-LS	36143312310	Double Nozzle Pencil 1.8CP	10pcs
HG13.212-LS	46683302430	Double Nozzle 2.0CP	10pcs	HG13.252-LS	36143312320	Double Nozzle Pencil 2.5CP	10pcs
HG13.213-LS	46683302440	Double Nozzle 2.5	10pcs	HG13.253-LS	36143312330	Double Nozzle Pencil 3.0CP	10pcs
HG13.220-LS	46143306480	Double Nozzle 2.5CP	10pcs	HG13.254-LS	36143312340	Double Nozzle Pencil 3.5CP	10pcs
HG13.210-LS	46683302450	Double Nozzle 3.0	10pcs	HG13.255-LS	36143312350	Double Nozzle Pencil 4.0CP	10pcs
HG13.214-LS	46683302450	Double Nozzle 3.0CP	10pcs	HG13.256-LS	Q6143312360	Double Nozzle Pencil 4.5CP	10pcs
HG13.221-LS	46143306500	Double Nozzle 3.5CP	10pcs	HG13.257-LS	Q6143312370	Double Nozzle Pencil 5.0CP	10pcs
HG13.215-LS	Q6283300030	Double Nozzle Smooth 6.0	10pcs	HG13.205-LS	46603350522-2.2	Nozzle 2.2mm	10pcs
HG13.216-LS	Q6283300020	Double Nozzle Smooth 7.5	10pcs	HG13.226-LS	46683301281-2.5	Nozzle 2.5mm	10pcs
HG13.217-LS	Q6283300010	Double Nozzle Smooth 9.5	10pcs	HG13.227-LS	46143310343	Nozzle Slim 1.2 CP	10pcs
HG10.681-LS	46143306490	Double Nozzle 3.0mm Hard CP	10pcs	HG13.228-LS	46143310353	Nozzle Slim 1.5 CP	10pcs
HG10.692D-LS	36143311500	Nozzle 1.5 mm Slim Double CP	10pcs	HG13.231-LS	46143310383	Nozzle Slim 3.0 CP	10pcs
HG10.694D-LS	36143311510	Nozzle 2.0 mm Slim Double CP	10pcs	HG13.233-LS	46143310402	Nozzle Slim 4.0 CP	10pcs
HG10.696D-LS	36143311520	Nozzle 2.5 mm Slim Double CP	10pcs	HG13.234-LS	36143312380	Nozzle 3.5mm Slim Double CP	10pcs
HG10.697D-LS	36143311530	Nozzle 3.0 mm Slim Double CP	10pcs	HG13.235-LS	36143312390	Nozzle 4.0mm Slim Double CP	10pcs
HG10.705-LS	46603350521-0.8	Nozzle 0.8mm	10pcs				
HG10.706-LS	46603350521-1.0	Nozzle 1.0mm	10pcs				
HG10.707-LS	46603350521-1.2	Nozzle 1.2mm	10pcs				

Last update of this page: 27/06/2022. See Revision history for details.

FOR US MARKET ONLY

THERMACUT® REPLACEMENT PARTS SUITABLE FOR MAZAK®

Part No.	Ref. No.	Description	Std. Pkg.	Part No.	Ref. No.	Description	Std. Pkg.
HG10.629-LS	36143304420	Nozzle Holder Hyper Gear	1pc	HG10.642	46143307420	Retainer Nut	1pc
HG10.630-LS	36143304400	Coupler	1pc	HG10.643-LS	46683301180	Screw	1pc
HG10.631-LS	46143300230	Replacement Ball Kit (6pcs)	1pc	HG10.644-LS	46143304440	Insulator - PTFE	1pc
HG10.632	46143304430	Spring Retainer	1pc	HG10.645-LS	46143300290	Retainer Nut	1pc
HG10.633-LS	46143308000	Spring Retainer - Steel	1pc	HG10.646-LS	46143300260	Insulator - PTFE	1pc
HG10.634-LS	46143300220	Spring	1pc	HG10.647-LS	46143300270	Insulator - PTFE	1pc
HG10.635-LS	36143303242	Body	1pc	HG10.648	46143300280	Retainer Nut	1pc
HG10.636-LS	36143307980	Aluminium Body	1pc	HG10.649-LS	46143300320	Ring - Brass	1pc
HG10.638-LS	46143308170	Spacer	1pc	HG10.667-LS	36143300332	Ring - Aluminum	1pc
HG10.639-LS	46143308190	Connector	1pc	HG10.686		Complete Head (PTFE Spacer)	1pc
HG10.640-LS	46143300240	Insulator - PTFE	1pc	HG10.687		Complete Head (PTFE Spacer)	1pc
HG10.641	46143304250	Retainer Nut	1pc	HG10.335-LS	46683301070	Base	1pc
HG10.345-LS	46683301140	Housing	1pc	HG13.424-LS	J2600S03200	O-Ring External Base - rubber	1pc
HG10.337	46683300032	Screw M5x0.5	1pc	HG13.430-LS	36143310550	Aluminum Body	1pc
HG10.433	36143310530	H.G. Coupler	1pc	HG13.423-LS	46602350080	Stylus Foot H9 Brass	1pc
HG13.400-LS	46683301920	Cover Clips PTFE	1pc	HG10.332-LS	46683301110	Bracket	1pc
HG13.427-LS	46683301171	Connector Assembly	1pc	HG10.339-LS	46683301100	Bracket	1pc
HG10.341-LS	46683300850	Nozzle Holder	1pc	HG10.343-LS	46683300000	Screw M2.5x4	1pc
HG10.347-LS	46683301160	Ring	1pc	HG10.346-LS	46683301150	PTFE Spacer 17x1.5	1pc
HG10.350-LS	46683301870	Cover Clips PTFE	1pc	HG10.390-LS	46683301930	PTFE Spacer	1pc
HG10.349-LS	46683301860	Connection Cover for cable PTFE	1pc	HG10.344-LS	46683301170	Connector	1pc
HG10.393-LS	46683301330	No Longer Available	1pc	HG10.336-LS	46683301090	PTFE Spacer 30x4	1pc
HG14.840-LS	46683301841	Nozzle Cover	1pc	HG10.340-LS	46683301120	PTFE Spacer 24x3	1pc
HG10.333-LS	46683301080	PTFE Spacer 27x5.5	1pc	HG13.414-LS	36143310522	Nozzle Adapter	1pc
HG10.342-LS	46683301130	PTFE spacer 24x4	1pc	HG13.417-LS	46143312170	Insulating Ring	1pc
HG13.428-LS	46773300710	Ceramic spacer 24x4	1pc	HG13.403-LS	46713300321	Vespel Nut - Space Gear	1pc
HG13.404-LS	46713330960	Washer for cone	1pc	HG13.429-LS	46683301930P	Special Protection - Peek	1pc
HG13.409-LS	46713330940	Torch Inner Tip	1pc	HG13.416-LS	46143312120	Insulating PPS 40x5	1pc
HG13.405-LS	P0492-702-00001	Insulating Ring	1pc	HG13.413-LS	46143312100	Insulating PPS 38x5.5	1pc
HG13.412-LS	46143312130	Insulating PPS 40x4	1pc	HG13.410-LS	46713330930	Inner Sensor Cone	1pc
HG13.406-LS	46713330920	Insulating Ring	1pc	HG13.402-LS	46683301851	Connector cover PTFE	1pc
HG10.434-LS	36143304401	Coupler	1pc	HG13.407-LS	46713330951	Connector Cap	1pc
HG13.401-LS	46683301910	Connector cover for cable PTFE	1pc				
HG13.408-LS	46713331111	Connector	1pc				

PolyTetraFluoroEthylene is a fluorocarbon-based polymer and is commonly abbreviated PTFE. The Teflon® brand of PTFE is manufactured only by DuPont® and is not sold by THERMACUT®. THERMACUT® purchases other brands of PTFE from various high quality manufacturers.

Last update of this page: 21/04/2022. See Revision history for details.

FOR US MARKET ONLY
THERMACUT® REPLACEMENT PARTS SUITABLE FOR
MAZAK®
LENSES SUITABLE FOR MAZAK®



Part No.	Ref. No.	Description	Std. Pkg.	Part No.	Ref. No.	Description	Std. Pkg.
HG10.167/H	HG10.167/H	5.00" ZnSe Meniscus lens High pressure lens (29bar), 38.1mm Effective focal length: 127.0mm Edge thickness: 7.4mm AR/AR for 10.6µm (absorption <0.20%)	1pc	HG15.016/H	HG15.016/H	7.50" ZnSe Plano-convex lens High pressure lens (29bar), 38.1mm Effective focal length: 190.5mm Edge thickness: 7.6mm AR/AR for 10.6µm (absorption <0.20%)	1pc
HG10.620/H ^{OD}	HG10.620/H	5.00" ZnSe Meniscus lens High pressure lens (28bar), 50.8mm Effective focal length: 127.0mm Edge thickness: 9.7mm AR/AR for 10.6µm (absorption <0.20%)	1pc	HG10.621/H	HG10.621/H	7.50" ZnSe Meniscus lens High pressure lens (28bar), 50.8mm Effective focal length: 190.5mm Edge thickness: 9.7mm AR/AR for 10.6µm (absorption <0.20%)	1pc
HG15.015/H	HG15.015/H	5.00" ZnSe Plano-convex lens High pressure lens (28bar), 38.1mm Effective focal length: 127.0mm Edge thickness: 7.6mm AR/AR for 10.6µm (absorption <0.20%)	1pc	HG15.028/H	HG15.028/H	7.50" ZnSe Plano-convex lens High pressure lens (19bar), 50.8mm Effective focal length: 190.5mm Edge thickness: 7.87mm AR/AR for 10.6µm (absorption <0.20%)	1pc
HG15.024/H ^{OD}	HG15.024/H	5.00" ZnSe Plano-convex lens High pressure lens (33bar), 38.1mm Effective focal length: 127.0mm Edge thickness: 7.87mm AR/AR for 10.6µm (absorption <0.20%)	1pc	HG15.003/H	HG15.003/H	7.50" ZnSe Plano-convex lens High pressure lens (28bar), 50.8mm Effective focal length: 190.5mm Edge thickness: 9.7mm AR/AR for 10.6µm (absorption <0.20%)	1pc
HG15.029/H ^{OD}	HG15.029/H	5.00" ZnSe Plano-convex lens High pressure lens (19bar), 50.8mm Effective focal length: 127.0mm Edge thickness: 7.87mm AR/AR for 10.6µm (absorption <0.20%)	1pc	HG10.167/HU	HG10.167/HU	5.00" ZnSe Men. lens - ULTRA LOW High pressure lens (29bar), 38.1mm Effective focal length: 127.0mm Edge thickness: 7.4mm AR/AR for 10.6µm (absorption <0.13%)	1pc
HG15.002/H	HG15.002/H	5.00" ZnSe Plano-convex lens High pressure lens (28bar), 50.8mm Effective focal length: 127.0mm Edge thickness: 9.7mm AR/AR for 10.6µm (absorption <0.20%)	1pc	HG10.168/HU	HG10.168/HU	7.50" ZnSe Men. lens - ULTRA LOW High pressure lens (29bar), 38.1mm Effective focal length: 190.5mm Edge thickness: 7.4mm AR/AR for 10.6µm (absorption <0.13%)	1pc
HG10.168/H	HG10.168/H	7.50" ZnSe Meniscus lens High pressure lens (29bar), 38.1mm Effective focal length: 190.5mm Edge thickness: 7.4mm AR/AR for 10.6µm (absorption <0.20%)	1pc				

FOR US MARKET ONLY
ACCESSORIES SUITABLE FOR MAZAK®

Part No.	Ref. No.	Description	Std. Pkg.
HG10.174	HG10.174	Polish for laser optics, 250ml, 0367432/2243066	1pc
HG10.173	HG10.173	Lens cleaning paper from TIFFEN®, sheet size 70 × 115mm	50pcs

^{OD} ON DEMAND – WE DO NOT KEEP THESE PARTS IN STOCK, COST IS SET ACCORDING TO THE ORDERED QUANTITY, DELIVERY TIME MAY DIFFER FROM STANDARD PRODUCTS.

Last update of this page: 21/04/2022. See Revision history for details.

THERMACUT® REPLACEMENT PARTS SUITABLE FOR MITSUBISHI®

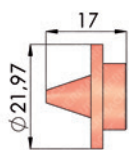

HG12.501-HG12.502

Double copper inserts

Part No.	Ref. No.	Description	Std. Pkg.	Part No.	Ref. No.	Description	Std. Pkg.
HG12.501	W270	Double Nozzle Insert 8-holes	10pcs	HG12.504	W515	Double Nozzle Insert 24-holes	10pcs
HG12.502	OD W387	Double Nozzle Insert 12-holes	10pcs	HG12.505	W269	Double Nozzle	1pc

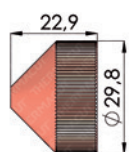

HG12.540-HG12.545

Part No.	Ref. No.	Description	Std. Pkg.	Part No.	Ref. No.	Description	Std. Pkg.
HG12.540	W1626	Nozzle 1.0mm	10pcs	HG12.545	W1629	Nozzle 2.0mm	10pcs
HG12.541	W1627	Nozzle 1.2mm	1pc	HG12.546	W1630	Nozzle 2.5mm	10pcs
HG12.543	W1628	Nozzle 1.5mm	10pcs	HG12.550	W1664	Nozzle 3.0mm	1pc
HG12.544	W1661	Nozzle 1.7mm	10pcs	HG12.551	W1665	Nozzle 3.5mm	10pcs

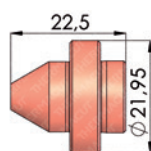

HG12.507-HG12.509

Part No.	Ref. No.	Description	Std. Pkg.	Part No.	Ref. No.	Description	Std. Pkg.
HG12.507	BQ943D157H01	Nozzle 1.5mm	10pcs	HG12.530	HG12.530	Nozzle Nut Short (15mm)	1pc
HG12.508	BQ943D157H02	Nozzle 2.0mm	10pcs				
HG12.509	BQ943D157H03	Nozzle 2.5mm	10pcs				
HG12.520	W777	Nozzle 1.2mm	10pcs				

OD ON DEMAND – WE DO NOT KEEP THESE PARTS IN STOCK, COST IS SET ACCORDING TO THE ORDERED QUANTITY, DELIVERY TIME MAY DIFFER FROM STANDARD PRODUCTS.

Last update of this page: 27/06/2022. See Revision history for details.

THERMACUT®
THE CUTTING COMPANY®

WWW.THERMACUT.COM
TEL.: +420 556 423 440
SALES@THERMACUT.CZ

THERMACUT®, THE CUTTING COMPANY®, FHT-EX®, EX-TRAFIRE®, EX-TRACK®, EX-TRABEAM® AND EX-TRAFLEAME® ARE REGISTERED TRADEMARKS OF THERMACUT, K.S. AND MAY BE REGISTERED IN CZECH REPUBLIC AND/OR OTHER COUNTRIES. ALL OTHER TRADEMARKS ARE PROPERTIES OF THEIR RESPECTIVE OWNERS. THERMACUT® IS IN NO WAY AFFILIATED WITH MITSUBISHI®. MOST THERMACUT® PARTS ARE MADE FOR OR BY AN IBG COMPANY.
VALID FROM SEPTEMBER 2022 • PREVIOUS VERSION IS NO LONGER VALID. • © COPYRIGHT 2022 BY THERMACUT® CZECH REPUBLIC. ALL RIGHTS RESERVED.

THERMACUT® REPLACEMENT PARTS SUITABLE FOR MITSUBISHI® LENSES SUITABLE FOR MITSUBISHI®



Part No.	Ref. No.	Description	Std. Pkg.	Part No.	Ref. No.	Description	Std. Pkg.
HG15.015/H	W500	5.00" ZnSe Plano-convex lens High pressure lens (29bar), 38.1mm Effective focal length: 127.0mm Edge thickness: 7.6mm AR/AR for 10.6µm (absorption <0.20%)	1pc	HG15.029/H OD	HG15.029/H	5.00" ZnSe Plano-convex lens High pressure lens (19bar), 50.8mm Effective focal length: 127.0mm Edge thickness: 7.87mm AR/AR for 10.6µm (absorption <0.20%)	1pc
HG15.024/H OD	W505	5.00" ZnSe Plano-convex lens High pressure lens (33bar), 38.1mm Effective focal length: 127.0mm Edge thickness: 7.87mm AR/AR for 10.6µm (absorption <0.20%)	1pc	HG15.002/H	W813	5.00" ZnSe Plano-convex lens High pressure lens (28bar), 50.8mm Effective focal length: 127.0mm Edge thickness: 9.7mm AR/AR for 10.6µm (absorption <0.20%)	1pc
HG15.028/H	W510	5.00" ZnSe Plano-convex lens High pressure lens (19bar), 50.8mm Effective focal length: 190.5mm Edge thickness: 7.87mm AR/AR for 10.6µm (absorption <0.20%)	1pc	HG15.029/HU	W505	5.00" ZnSe Plan.-con. - ULTRA LOW High pressure lens (19bar), 50.8mm Effective focal length: 127.0mm Edge thickness: 7.87mm AR/AR for 10.6µm (absorption <0.13%)	1pc
HG15.016/H	HG15.016/H	7.50" ZnSe Plano-convex lens High pressure lens (29bar), 38.1mm Effective focal length: 190.5mm Edge thickness: 7.6mm AR/AR for 10.6µm (absorption <0.20%)	1pc	HG15.002/HU	W813	5.00" ZnSe Plan.-con. - ULTRA LOW High pressure lens (19bar), 50.8mm Effective focal length: 127.0mm Edge thickness: 9.7mm AR/AR for 10.6µm (absorption <0.13%)	1pc
HG15.003/H	W015	7.50" ZnSe Plano-convex lens High pressure lens (29bar), 50.8mm Effective focal length: 190.5mm Edge thickness: 9.7mm AR/AR for 10.6µm (absorption <0.20%)	1pc	HG15.028/HU	W510UL	7.50" ZnSe Plan.-con. - ULTRA LOW High pressure lens (19bar), 50.8mm Effective focal length: 190.5mm Edge thickness: 7.87mm AR/AR for 10.6µm (absorption <0.13%)	1pc
HG15.015/HU OD	W500	5.00" ZnSe Plan.-con. - ULTRA LOW High pressure lens (29bar), 38.1mm Effective focal length: 127.0mm Edge thickness: 7.6mm AR/AR for 10.6µm (absorption <0.13%)	1pc	HG15.003/HU OD	W015UL	7.50" ZnSe Plan.-con. - ULTRA LOW High pressure lens (28bar), 50.8mm Effective focal length: 190.5mm Edge thickness: 9.7mm AR/AR for 10.6µm (absorption <0.13%)	1pc

ACCESSORIES SUITABLE FOR MITSUBISHI®

Part No.	Ref. No.	Description	Std. Pkg.
HG10.174	HG10.174	Polish for laser optics, 250ml, 0367432/2243066	1pc
HG10.173	HG10.173	Lens cleaning paper from TIFFEN®, sheet size 70 x 115mm	50pcs
HG15.136 OD	HG15.136	Latex gloves	100pcs

OD ON DEMAND – WE DO NOT KEEP THESE PARTS IN STOCK, COST IS SET ACCORDING TO THE ORDERED QUANTITY, DELIVERY TIME MAY DIFFER FROM STANDARD PRODUCTS.

Last update of this page: 08/02/2022. See Revision history for details.

THERMACUT®
THE CUTTING COMPANY®

WWW.THERMACUT.COM
TEL.: +420 556 423 440
SALES@THERMACUT.CZ

THERMACUT®, THE CUTTING COMPANY®, FHT-EX®, EX-TRAFIRE®, EX-TRACK®, EX-TRABEAM® AND EX-TRAFLEAME® ARE REGISTERED TRADEMARKS OF THERMACUT, K.S. AND MAY BE REGISTERED IN CZECH REPUBLIC AND/OR OTHER COUNTRIES. ALL OTHER TRADEMARKS ARE PROPERTIES OF THEIR RESPECTIVE OWNERS. THERMACUT® IS IN NO WAY AFFILIATED WITH MITSUBISHI® AND THE TIFFEN COMPANY. MOST THERMACUT® PARTS ARE MADE FOR OR BY AN IBG COMPANY.
VALID FROM SEPTEMBER 2022 • PREVIOUS VERSION IS NO LONGER VALID. • © COPYRIGHT 2022 BY THERMACUT® CZECH REPUBLIC. ALL RIGHTS RESERVED.

THERMACUT® REPLACEMENT PARTS SUITABLE FOR Precitec®

Precitec® (Weidmüller®), ADIGE® SALA, ESAB®, GHT™, HACO®, BALLIU™,
FINN-POWER®, CR electronic®, MESSER-GRIESHEIM®



HG11.100

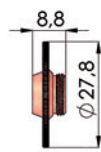

HG11.139

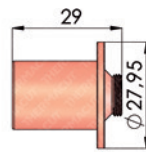

HG11.160

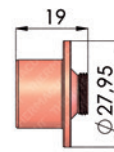

HG11.161

Part No.	Ref. No.	Description	Std. Pkg.	Part No.	Ref. No.	Description	Std. Pkg.
HG11.100	P0571-1051-00001	Ceramic Nozzle Holder	1pc			Length 19mm - Flatbed	
HG11.139	HG11.139	Nozzle Adapter for TRUMPF® Flatbed	1pc	HG11.162	004.4312.041	Nozzle Adapter for TRUMPF® Length 30mm - TLC®	1pc
HG11.160	004.4312.040	Nozzle Adapter for TRUMPF® Length 29mm - Flatbed	1pc	HG11.163 OD	004.4312.034	Nozzle Adapter for TRUMPF® Length 20mm - TLC®	1pc
HG11.161	004.4312.032	Nozzle Adapter for TRUMPF®	1pc				



HG11.120-HG11.125

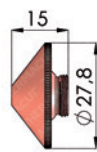

HG11.126-HG11.138

Standard copper nozzles / Double copper nozzles

Part No.	Ref. No.	Description	Std. Pkg.	Part No.	Ref. No.	Description	Std. Pkg.
HG11.120	P0571-291-00010	Nozzle 1.0mm	10pcs	HG11.128	HG11.128	Nozzle 3.5mm	10pcs
HG11.121	P0571-292-00012	Nozzle 1.2mm	10pcs	HG11.127	P0591-578-00040	Nozzle 4.0mm	10pcs
HG11.122	P0571-293-00015	Nozzle 1.5mm	10pcs	HG11.126	P0591-579-00050	Nozzle 5.0mm	10pcs
HG11.123	P0571-294-00018	Nozzle 1.8mm	10pcs	HG11.300	P0591-002-00010	Double Nozzle 1.0mm	10pcs
HG11.124 OD	P0571-295-00020	Nozzle 2.0mm	10pcs	HG11.301	P0591-002-00012	Double Nozzle 1.2mm	10pcs
HG11.125 OD	P0571-297-00025	Nozzle 2.5mm	10pcs	HG11.302	P0591-002-00015	Double Nozzle 1.5mm	10pcs
HG11.129	P0591-673-00008	Nozzle 0.8mm	10pcs	HG11.303	P0591-002-00018	Double Nozzle 1.8mm	10pcs
HG11.130	P0591-571-00010	Nozzle 1.0mm	10pcs	HG11.304	P0591-002-00020	Double Nozzle 2.0mm	10pcs
HG11.131	P0591-572-00012	Nozzle 1.2mm	10pcs	HG11.305	P0591-002-00023	Double Nozzle 2.3mm	10pcs
HG11.132	P0591-573-00015	Nozzle 1.5mm	10pcs	HG11.306	P0591-002-00025	Double Nozzle 2.5mm	10pcs
HG11.133	P0591-574-00018	Nozzle 1.8mm	10pcs	HG11.307	P0591-002-00030	Double Nozzle 3.0mm	10pcs
HG11.134	P0591-575-00020	Nozzle 2.0mm	10pcs	HG11.308	P0591-002-00035	Double Nozzle 3.5mm	10pcs
HG11.135	HG11.135	Nozzle 2.3mm	10pcs	HG11.150	P0571-281-00010	Nozzle 1.0mm	10pcs
HG11.136	P0591-576-00025	Nozzle 2.5mm	10pcs				
HG11.137	HG11.137	Nozzle 2.7mm	10pcs				
HG11.138	P0591-577-00030	Nozzle 3.0mm	10pcs				

OD ON DEMAND – WE DO NOT KEEP THESE PARTS IN STOCK, COST IS SET ACCORDING TO THE ORDERED QUANTITY, DELIVERY TIME MAY DIFFER FROM STANDARD PRODUCTS.

Last update of this page: 27/06/2022. See Revision history for details.

THERMACUT®
THE CUTTING COMPANY®

WWW.THERMACUT.COM
TEL.: +420 556 423 440
SALES@THERMACUT.CZ

THERMACUT®, THE CUTTING COMPANY®, FHT-EX®, EX-TRAFIRE®, EX-TRACK®, EX-TRABEAM® AND EX-TRAFLEAME® ARE REGISTERED TRADEMARKS OF THERMACUT, K.S. AND MAY BE REGISTERED IN CZECH REPUBLIC AND/OR OTHER COUNTRIES. ALL OTHER TRADEMARKS ARE PROPERTIES OF THEIR RESPECTIVE OWNERS. THERMACUT® IS NO WAY AFFILIATED WITH Precitec®, Weidmüller®, ADIGE® SALA, ESAB®, HACO®, FINN-POWER®, CR electronic®, MESSER-GRIESHEIM®, TRUMPF®, TLC®. MOST THERMACUT® PARTS ARE MADE FOR OR BY AN IBG COMPANY.

VALID FROM SEPTEMBER 2022 • PREVIOUS VERSION IS NO LONGER VALID. • © COPYRIGHT 2022 BY THERMACUT® CZECH REPUBLIC. ALL RIGHTS RESERVED.

THERMACUT® REPLACEMENT PARTS SUITABLE FOR Precitec®

Precitec® (Weidmüller®), ADIGE® SALA, ESAB®, GHT™, HACO®, BALLIU™,
FINN-POWER®, CR electronic®, MESSER-GRIESHEIM®

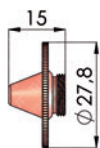

HG11.101-HG11.105

Standard copper nozzles

Part No.	Ref. No.	Description	Std. Pkg.	Part No.	Ref. No.	Description	Std. Pkg.
HG11.101	P0591-569-00008	Nozzle 0.8mm	10pcs	HG11.105	P0591-564-00018	Nozzle 1.8mm	10pcs
HG11.102	P0591-561-00010	Nozzle 1.0mm	10pcs	HG11.106	P0591-565-00020	Nozzle 2.0mm	10pcs
HG11.103	P0591-562-00012	Nozzle 1.2mm	10pcs	HG11.108	P0591-566-00025	Nozzle 2.5mm	10pcs
HG11.104	P0591-563-00015	Nozzle 1.5mm	10pcs				

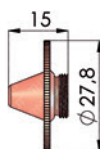

HG11.020



HG11.021
HG11.022

Part No.	Ref. No.	Description	Std. Pkg.	Part No.	Ref. No.	Description	Std. Pkg.
HG11.020	P0578-0411-00010	Nozzle 1.0mm	10pcs	HG11.024	P0578-0415-00020	Nozzle 2.0mm	10pcs
HG11.021	P0578-0412-00012	Nozzle 1.2mm	10pcs				
HG11.022	P0578-0413-00015	Nozzle 1.5mm	10pcs				
HG11.023	P0578-0414-00018	Nozzle 1.8mm	10pcs				

Long copper nozzles

Part No.	Ref. No.	Description	Std. Pkg.	Part No.	Ref. No.	Description	Std. Pkg.
HG11.141	P0573-563-00012	Long Nozzle 1.2mm	10pcs	HG11.146	P0573-566-00025	Long Nozzle 2.5mm	10pcs
HG11.142	P0573-563-00015	Long Nozzle 1.5mm	10pcs	HG11.147	HG11.147	Long Nozzle 3.0mm	10pcs
HG11.144	P0573-564-00020	Long Nozzle 2.0mm	10pcs				
HG11.145	P0573-565-00023	Long Nozzle 2.3mm	10pcs				

Last update of this page: 22/08/2022. See Revision history for details.

THERMACUT®
THE CUTTING COMPANY®

WWW.THERMACUT.COM
TEL.: +420 556 423 440
SALES@THERMACUT.CZ

THERMACUT®, THE CUTTING COMPANY®, FHT-EX®, EX-TRAFIRE®, EX-TRACK®, EX-TRABEAM® AND EX-TRAFLEAME® ARE REGISTERED TRADEMARKS OF THERMACUT, K.S. AND MAY BE REGISTERED IN CZECH REPUBLIC AND/OR OTHER COUNTRIES. ALL OTHER TRADEMARKS ARE PROPERTIES OF THEIR RESPECTIVE OWNERS. THERMACUT® IS NO WAY AFFILIATED WITH Precitec®, Weidmüller®, ADIGE® SALA, ESAB®, HACO®, FINN-POWER®, CR electronic®, MESSER-GRIESHEIM®. MOST THERMACUT® PARTS ARE MADE FOR OR BY AN IBG COMPANY. VALID FROM SEPTEMBER 2022 • PREVIOUS VERSION IS NO LONGER VALID. • © COPYRIGHT 2022 BY THERMACUT® CZECH REPUBLIC. ALL RIGHTS RESERVED.

THERMACUT® REPLACEMENT PARTS SUITABLE FOR Precitec®

Precitec® (Weidmüller®), ADIGE® SALA, ESAB®, GHT™, HACO®, BALLIU™,
FINN-POWER®, CR electronic®, MESSER-GRIESHEIM®

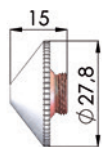

HG11.129/C–HG11.134/C

Standard copper nozzles with chromium plating

Part No.	Ref. No.	Description	Std. Pkg.	Part No.	Ref. No.	Description	Std. Pkg.
HG11.129/C OD	P0591-673-0008CP	Nozzle 0.8mm HCP	10pcs	HG11.135/C OD	HG11.135CP	Nozzle 2.3mm HCP	10pcs
HG11.130/C	P0591-571-00010CP	Nozzle 1.0mm HCP	10pcs	HG11.136/C	P0591-576-00025CP	Nozzle 2.5mm HCP	10pcs
HG11.131/C	P0591-572-00012CP	Nozzle 1.2mm HCP	10pcs	HG11.137/C	HG11.137CP	Nozzle 2.7mm HCP	10pcs
HG11.132/C	P0591-573-00015CP	Nozzle 1.5mm HCP	10pcs	HG11.138/C	P0591-577-00030CP	Nozzle 3.0mm HCP	10pcs
HG11.133/C OD	P0591-574-00018CP	Nozzle 1.8mm HCP	10pcs	HG11.128/C	HG11.128CP	Nozzle 3.5mm HCP	10pcs
HG11.134/C	P0591-575-00020CP	Nozzle 2.0mm HCP	10pcs				

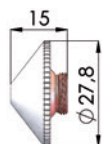

HG11.300/C–HG11.304/C

Double copper nozzles with chromium plating

Part No.	Ref. No.	Description	Std. Pkg.	Part No.	Ref. No.	Description	Std. Pkg.
HG11.300/C	P0591-002-00010CP	Double Nozzle 1.0mm HCP	10pcs	HG11.306/C	P0591-002-00025CP	Double Nozzle 2.5mm HCP	10pcs
HG11.301/C	P0591-002-00012CP	Double Nozzle 1.2mm HCP	10pcs	HG11.307/C	P0591-002-00030CP	Double Nozzle 3.0mm HCP	10pcs
HG11.302/C	P0591-002-00015CP	Double Nozzle 1.5mm HCP	10pcs	HG11.308/C OD	P0591-002-00035CP	Double Nozzle 3.5mm HCP	10pcs
HG11.303/C	P0591-002-00018CP	Double Nozzle 1.8mm HCP	10pcs				
HG11.304/C	P0591-002-00020CP	Double Nozzle 2.0mm HCP	10pcs				
HG11.305/C	P0591-002-00023CP	Double Nozzle 2.3mm HCP	10pcs				

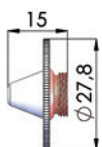

HG11.103/C–HG11.104/C

Standard copper nozzles with chromium plating

Part No.	Ref. No.	Description	Std. Pkg.	Part No.	Ref. No.	Description	Std. Pkg.
HG11.103/C OD	P0591-562-00012CP	Nozzle 1.2mm HCP	10pcs	HG11.110/C	P0591-568-00030CP	Nozzle 3.0mm HCP	10pcs
HG11.104/C OD	P0591-563-00015CP	Nozzle 1.5mm HCP	10pcs				
HG11.106/C	P0591-565-00020CP	Nozzle 2.0mm HCP	10pcs				
HG11.109/C	HG11.109CP	Nozzle 2.7mm HCP	10pcs				

OD ON DEMAND – WE DO NOT KEEP THESE PARTS IN STOCK, COST IS SET ACCORDING TO THE ORDERED QUANTITY, DELIVERY TIME MAY DIFFER FROM STANDARD PRODUCTS.

Last update of this page: 27/06/2022. See Revision history for details.

THERMACUT®
THE CUTTING COMPANY®

WWW.THERMACUT.COM
TEL.: +420 556 423 440
SALES@THERMACUT.CZ

THERMACUT®, THE CUTTING COMPANY®, FHT-EX®, EX-TRAFIRE®, EX-TRACK®, EX-TRABEAM® AND EX-TRAFLEAME® ARE REGISTERED TRADEMARKS OF THERMACUT, K.S. AND MAY BE REGISTERED IN CZECH REPUBLIC AND/OR OTHER COUNTRIES. ALL OTHER TRADEMARKS ARE PROPERTIES OF THEIR RESPECTIVE OWNERS. THERMACUT® IS NO WAY AFFILIATED WITH Precitec®, Weidmüller®, ADIGE® SALA, ESAB®, HACO®, FINN-POWER®, CR electronic®, MESSER-GRIESHEIM®. MOST THERMACUT® PARTS ARE MADE FOR OR BY AN IBG COMPANY. VALID FROM SEPTEMBER 2022 • PREVIOUS VERSION IS NO LONGER VALID. • © COPYRIGHT 2022 BY THERMACUT® CZECH REPUBLIC. ALL RIGHTS RESERVED.

THERMACUT® REPLACEMENT PARTS SUITABLE FOR Precitec® Precitec® (Weidmüller®) 5" KN/MG

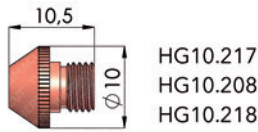

Standard copper nozzels

Part No.	Ref. No.	Description	Std. Pkg.	Part No.	Ref. No.	Description	Std. Pkg.
HG10.217	P0494-853-00010	Nozzle 1.0mm	10pcs	HG10.226	HG10.226	Slop-Cutting Nozzle 1.2mm	10pcs
HG10.208	P0494-854-00012	Nozzle 1.2mm	10pcs	HG10.220 OD	HG10.220	Slop-Cutting Nozzle 1.4mm	10pcs
HG10.218	P0494-855-00015	Nozzle 1.5mm	10pcs	HG10.221 OD	HG10.221	Slop-Cutting Nozzle 1.7mm	10pcs
HG10.225	HG10.225	Slop-Cutting Nozzle 1.0mm	10pcs				

SUITABLE FOR Precitec® DE YR30

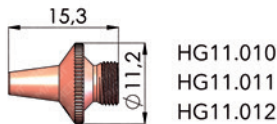

Part No.	Ref. No.	Description	Std. Pkg.	Part No.	Ref. No.	Description	Std. Pkg.
HG11.010	P0787-481-00010	Nozzle 1.0mm	10pcs	HG11.014 OD	P0787-1001-00020	Nozzle 2.0mm	10pcs
HG11.011	P0787-482-00012	Nozzle 1.2mm	10pcs				
HG11.012 OD	P0787-483-00015	Nozzle 1.5mm	10pcs				
HG11.013 OD	P0787-1002-00017	Nozzle 1.7mm	10pcs				

LENSES SUITABLE FOR Precitec®



Part No.	Ref. No.	Description	Std. Pkg.	Part No.	Ref. No.	Description	Std. Pkg.
HG10.731/H	HG10.731/H	5.00" ZnSe Meniscus lens High pressure lens (20bar), 38.1mm Effective focal length: 127.0mm Edge thickness: 6.0mm AR/AR for 10.6µm (absorption <0.20%)	1pc	HG10.166/H	HG10.166/H	3.75" ZnSe Meniscus lens High pressure lens (29bar), 38.1mm Effective focal length: 95.3mm Edge thickness: 7.4mm AR/AR for 10.6µm (absorption <0.20%)	1pc
HG10.732/H	HG10.732/H	7.50" ZnSe Meniscus lens High pressure lens (20bar), 38.1mm Effective focal length: 190.5mm Edge thickness: 6.0mm AR/AR for 10.6µm (absorption <0.20%)	1pc	HG10.167/H	HG10.167/H	5.00" ZnSe Meniscus lens High pressure lens (29bar), 38.1mm Effective focal length: 127.0mm Edge thickness: 7.4mm AR/AR for 10.6µm (absorption <0.20%)	1pc

OD ON DEMAND – WE DO NOT KEEP THESE PARTS IN STOCK, COST IS SET ACCORDING TO THE ORDERED QUANTITY, DELIVERY TIME MAY DIFFER FROM STANDARD PRODUCTS.

Last update of this page: 27/06/2022. See Revision history for details.

THERMACUT®
THE CUTTING COMPANY®

WWW.THERMACUT.COM
TEL.: +420 556 423 440
SALES@THERMACUT.CZ

THERMACUT®, THE CUTTING COMPANY®, FHT-EX®, EX-TRAFIRE®, EX-TRACK®, EX-TRABEAM® AND EX-TRAFLEAME® ARE REGISTERED TRADEMARKS OF THERMACUT, K.S. AND MAY BE REGISTERED IN CZECH REPUBLIC AND/OR OTHER COUNTRIES. ALL OTHER TRADEMARKS ARE PROPERTIES OF THEIR RESPECTIVE OWNERS. THERMACUT® IS IN NO WAY AFFILIATED WITH Precitec®, Weidmüller®. MOST THERMACUT® PARTS ARE MADE FOR OR BY AN IBG COMPANY.
VALID FROM SEPTEMBER 2022 • PREVIOUS VERSION IS NO LONGER VALID. • © COPYRIGHT 2022 BY THERMACUT® CZECH REPUBLIC. ALL RIGHTS RESERVED.

**THERMACUT® REPLACEMENT PARTS SUITABLE FOR
Precitec®
LENSES SUITABLE FOR Precitec®**



Part No.	Ref. No.	Description	Std. Pkg.	Part No.	Ref. No.	Description	Std. Pkg.
HG10.168/H	HG10.168/H	7.50" ZnSe Meniscus lens High pressure lens (29bar), 38.1mm Effective focal length: 190.5mm Edge thickness: 7.4mm AR/AR for 10.6µm (absorption <0.20%)	1pc	HG10.168/HU	HG10.168/HU	7.50" ZnSe Men. lens - ULTRA LOW High pressure lens (29bar), 38.1mm Effective focal length: 190.5mm Edge thickness: 7.4mm AR/AR for 10.6µm (absorption <0.13%)	1pc
HG10.733/H	HG10.733/H	5.00" ZnSe Meniscus lens High pressure lens (42bar), 38.1mm Effective focal length: 127.0mm Edge thickness: 9.0mm AR/AR for 10.6µm (absorption <0.20%)	1pc	HG15.003/HU ^{OD}	HG15.003/HU	7.50" ZnSe Plan.-con. - ULTRA LOW High pressure lens (28bar), 50.8mm Effective focal length: 190.5mm Edge thickness: 9.7mm AR/AR for 10.6µm (absorption <0.13%)	1pc
HG10.734/H	HG10.734/H	7.50" ZnSe Meniscus lens High pressure lens (42bar), 38.1mm Effective focal length: 190.5mm Edge thickness: 9.0mm AR/AR for 10.6µm (absorption <0.20%)	1pc	HG10.733/HU	HG10.733/HU	5.00" ZnSe Men. lens - ULTRA LOW High pressure lens (42bar), 38.1mm Effective focal length: 127.0mm Edge thickness: 9.0mm AR/AR for 10.6µm (absorption <0.13%)	1pc
HG10.620/H ^{OD}	HG10.620/H	5.00" ZnSe Meniscus lens High pressure lens (42bar), 50.8mm Effective focal length: 127.0mm Edge thickness: 9.7mm AR/AR for 10.6µm (absorption <0.20%)	1pc	HG10.734/HU	HG10.734/HU	7.50" ZnSe Men. lens - ULTRA LOW High pressure lens (42bar), 38.1mm Effective focal length: 190.5mm Edge thickness: 9.0mm AR/AR for 10.6µm (absorption <0.13%)	1pc
HG10.621/H	HG10.621/H	7.50" ZnSe Meniscus lens High pressure lens (28bar), 50.8mm Effective focal length: 190.5mm Edge thickness: 9.7mm AR/AR for 10.6µm (absorption <0.20%)	1pc	HG15.002/HU	HG15.002/HU	5.00" ZnSe Plan.-con. - ULTRA LOW High pressure lens (28bar), 50.8mm Effective focal length: 127.0mm Edge thickness: 9.7mm AR/AR for 10.6µm (absorption <0.13%)	1pc
HG15.002/H	HG15.002/H	5.00" ZnSe Plano-convex lens High pressure lens (28bar), 50.8mm Effective focal length: 127.0mm Edge thickness: 9.7mm AR/AR for 10.6µm (absorption <0.20%)	1pc				
HG15.003/H	HG15.003/H	7.50" ZnSe Plano-convex lens High pressure lens (28bar), 50.8mm Effective focal length: 190.5mm Edge thickness: 9.7mm AR/AR for 10.6µm (absorption <0.20%)	1pc				
HG10.167/HU	HG10.167/HU	5.00" ZnSe Men. lens - ULTRA LOW High pressure lens (29bar), 38.1mm Effective focal length: 127.0mm Edge thickness: 7.4mm AR/AR for 10.6µm (absorption <0.13%)	1pc				

^{OD} ON DEMAND – WE DO NOT KEEP THESE PARTS IN STOCK, COST IS SET ACCORDING TO THE ORDERED QUANTITY, DELIVERY TIME MAY DIFFER FROM STANDARD PRODUCTS.

Last update of this page: 01/03/2022. See Revision history for details.

THERMACUT® REPLACEMENT PARTS SUITABLE FOR Precitec® PROTECTION WINDOWS SUITABLE FOR Precitec®

Part No.	Ref. No.	Description	Std. Pkg.
HG17.511	OD HG17.511	Protection Window D50.00mm × ET = 2.0mm suitable for Precitec®	1pc
HG17.514	HG17.514	Protection Window D25.40mm × ET = 4.0mm suitable for Precitec®	1pc
HG17.524	P0595-58601	Protection Window D37.00mm × ET = 7.0mm suitable for Precitec®	1pc
HG17.525	HG17.525	Protection Window D21.50mm × ET = 2.0mm suitable for Precitec®	1pc
HG17.526	766719	Protection Window D30.00mm × ET = 5.0mm suitable for TRUMPF®	1pc
HG17.527	HG17.527	Protection Window D30.00mm × ET = 1.50mm YW30 suitable for Precitec®	1pc
HG17.512	P0589-360-00001	Protection Window D22.35mm × ET = 4.0mm suitable for Precitec®	1pc

ACCESSORIES SUITABLE FOR Precitec®

Part No.	Ref. No.	Description	Std. Pkg.
HG10.174	HG10.174	Polish for laser optics, 250ml, 0367432/2243066	1pc
HG10.173	HG10.173	Lens cleaning paper from TIFFEN®, sheet size 70 × 115mm	50pcs

OD ON DEMAND – WE DO NOT KEEP THESE PARTS IN STOCK, COST IS SET ACCORDING TO THE ORDERED QUANTITY, DELIVERY TIME MAY DIFFER FROM STANDARD PRODUCTS.

Last update of this page: 08/02/2022. See Revision history for details.

THERMACUT®
THE CUTTING COMPANY®

WWW.THERMACUT.COM
TEL.: +420 556 423 440
SALES@THERMACUT.CZ

THERMACUT®, THE CUTTING COMPANY®, FHT-EX®, EX-TRAFIRE®, EX-TRACK®, EX-TRABEAM® AND EX-TRAFLEAME® ARE REGISTERED TRADEMARKS OF THERMACUT, K.S. AND MAY BE REGISTERED IN CZECH REPUBLIC AND/OR OTHER COUNTRIES. ALL OTHER TRADEMARKS ARE PROPERTIES OF THEIR RESPECTIVE OWNERS. THERMACUT® IS IN NO WAY AFFILIATED WITH Precitec®, TRUMPF® AND THE TIFFEN COMPANY. MOST THERMACUT® PARTS ARE MADE FOR OR BY AN IBG COMPANY.
VALID FROM SEPTEMBER 2022 • PREVIOUS VERSION IS NO LONGER VALID. • © COPYRIGHT 2022 BY THERMACUT® CZECH REPUBLIC. ALL RIGHTS RESERVED.

THERMACUT® REPLACEMENT PARTS SUITABLE FOR PRIMA POWER®

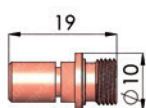

HG10.370

Standard copper nozzles

Part No.	Ref. No.	Description	Std. Pkg.	Part No.	Ref. No.	Description	Std. Pkg.
HG10.370	485.73.114E	Nozzle 2.0mm (485.73.322)	10pcs	HG10.451	HG10.451	Nozzle 2.5mm	10pcs
HG10.371	485.73.114F	Nozzle 2.5mm (485.73.323)	10pcs				

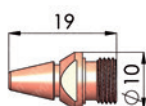

HG10.367
HG10.369
HG10.373

Part No.	Ref. No.	Description	Std. Pkg.	Part No.	Ref. No.	Description	Std. Pkg.
HG10.367	485.73.115A	Nozzle 1.5mm (485.73.331)	10pcs	HG11.367	485.73.451	Nozzle 1.5mm	10pcs
HG10.369	485.73.115C	Nozzle 2.0mm (485.73.333)	10pcs	HG11.369	485.73.452	Nozzle 2.0mm	10pcs
HG10.373	485.73.115F	Nozzle 2.5mm	10pcs	HG11.373	485.73.453	Nozzle 2.5mm	10pcs

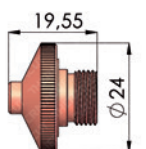

HG10.380-HG10.382

Part No.	Ref. No.	Description	Std. Pkg.	Part No.	Ref. No.	Description	Std. Pkg.
HG10.380	LW6.1E.111	Nozzle 1.5mm	10pcs	HG10.454	LW6.1G.600	Nozzle 1.5mm	10pcs
HG10.381	LW6.1E.112	Nozzle 2.0mm	10pcs	HG10.455	LW6.1G.601	Nozzle 2.0mm	10pcs
HG10.382	LW6.1E.113	Nozzle 2.5mm	10pcs	HG10.456	LW6.1G.602	Nozzle 2.5mm	10pcs
HG10.383 OD	LW6.1E.114	Nozzle 3.0mm	10pcs				

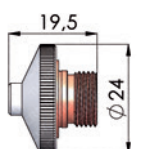

HG10.780

Part No.	Ref. No.	Description	Std. Pkg.	Part No.	Ref. No.	Description	Std. Pkg.
HG10.780 OD	LW6.1G.604	Nozzle 1.5mm CP	10pcs	HG10.782	LW6.1G.605	Nozzle 2.0mm CP	10pcs
HG10.781	HG10.781	Nozzle 1.75mm CP	10pcs	HG10.784	LW6.1G.607	Nozzle 3.0mm CP	10pcs

Part No.	Ref. No.	Description	Std. Pkg.
HG11.369/C	485.73.452CP	Nozzle 2.0mm	10pcs
HG11.373/C	485.73.453CP	Nozzle 2.5mm	10pcs

OD ON DEMAND – WE DO NOT KEEP THESE PARTS IN STOCK, COST IS SET ACCORDING TO THE ORDERED QUANTITY, DELIVERY TIME MAY DIFFER FROM STANDARD PRODUCTS.

Last update of this page: 22/08/2022. See Revision history for details.

THERMACUT®
THE CUTTING COMPANY®

WWW.THERMACUT.COM
TEL.: +420 556 423 440
SALES@THERMACUT.CZ

THERMACUT®, THE CUTTING COMPANY®, FHT-EX®, EX-TRAFIRE®, EX-TRACK®, EX-TRABEAM® AND EX-TRAFLEAME® ARE REGISTERED TRADEMARKS OF THERMACUT, K.S. AND MAY BE REGISTERED IN CZECH REPUBLIC AND/OR OTHER COUNTRIES. ALL OTHER TRADEMARKS ARE PROPERTIES OF THEIR RESPECTIVE OWNERS. THERMACUT® IS IN NO WAY AFFILIATED WITH PRIMA POWER®. MOST THERMACUT® PARTS ARE MADE FOR OR BY AN IBG COMPANY.
VALID FROM SEPTEMBER 2022 • PREVIOUS VERSION IS NO LONGER VALID. • © COPYRIGHT 2022 BY THERMACUT® CZECH REPUBLIC. ALL RIGHTS RESERVED.

THERMACUT® REPLACEMENT PARTS SUITABLE FOR PRIMA POWER®

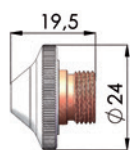

HG11.381/C

Domino copper nozzels with chromium plating

Part No.	Ref. No.	Description	Std. Pkg.
HG11.381/C OD	1059.70000.004	Double Nozzle 1.5mm HCP	10pcs
HG11.382/C	1059.70000.005	Double Nozzle 2.0mm HCP	10pcs



PRODUCT BROCHURE WITH DETAILS AT
WWW.THERMACUT.COM

▶ VIDEO AVAILABLE AT YOUTUBE CHANNEL ▶



LENSES SUITABLE FOR PRIMA POWER®

Part No.	Ref. No.	Description	Std. Pkg.	Part No.	Ref. No.	Description	Std. Pkg.
HG10.733/H	HG10.733/H	5.00" ZnSe Meniscus lens High pressure lens (42bar), 38.1mm Effective focal length: 127.0mm Edge thickness: 9.0mm AR/AR for 10.6µm (absorption <0.20%)	1pc	HG10.733/HU	HG10.733/HU	5.00" ZnSe Men. lens - ULTRA LOW High pressure lens (42bar), 38.1mm Effective focal length: 127.0mm Edge thickness: 9.0mm AR/AR for 10.6µm (absorption <0.13%)	1pc
HG10.734/H	HG10.734/H	7.50" ZnSe Meniscus lens High pressure lens (42bar), 38.1mm Effective focal length: 190.5mm Edge thickness: 9.0mm AR/AR for 10.6µm (absorption <0.20%)	1pc	HG10.734/HU	HG10.734/HU	7.50" ZnSe Men. lens - ULTRA LOW High pressure lens (42bar), 38.1mm Effective focal length: 190.5mm Edge thickness: 9.0mm AR/AR for 10.6µm (absorption <0.13%)	1pc
HG10.620/H OD	HG10.620/H	5.00" ZnSe Meniscus lens High pressure lens (28bar), 50.8mm Effective focal length: 127.0mm Edge thickness: 9.7mm AR/AR for 10.6µm (absorption <0.20%)	1pc				
HG10.621/H	HG10.621/H	7.50" ZnSe Meniscus lens High pressure lens (28bar), 50.8mm Effective focal length: 190.5mm Edge thickness: 9.7mm AR/AR for 10.6µm (absorption <0.20%)	1pc				

ACCESSORIES SUITABLE FOR PRIMA POWER®

Part No.	Ref. No.	Description	Std. Pkg.
HG10.174	HG10.174	Polish for laser optics, 250ml, 0367432/2243066	1pc
HG10.173	HG10.173	Lens cleaning paper from TIFFEN®, sheet size 70 × 115mm	50pcs

OD ON DEMAND – WE DO NOT KEEP THESE PARTS IN STOCK, COST IS SET ACCORDING TO THE ORDERED QUANTITY, DELIVERY TIME MAY DIFFER FROM STANDARD PRODUCTS.

Last update of this page: 22/08/2022. See Revision history for details.

THERMACUT®
THE CUTTING COMPANY®

WWW.THERMACUT.COM
TEL.: +420 556 423 440
SALES@THERMACUT.CZ

THERMACUT®, THE CUTTING COMPANY®, FHT-EX®, EX-TRAFIRE®, EX-TRACK®, EX-TRABEAM® AND EX-TRAFLEAME® ARE REGISTERED TRADEMARKS OF THERMACUT, K.S. AND MAY BE REGISTERED IN CZECH REPUBLIC AND/OR OTHER COUNTRIES. ALL OTHER TRADEMARKS ARE PROPERTIES OF THEIR RESPECTIVE OWNERS. THERMACUT® IS IN NO WAY AFFILIATED WITH PRIMA POWER® AND THE TIFFEN COMPANY. MOST THERMACUT® PARTS ARE MADE FOR OR BY AN IBG COMPANY.
VALID FROM SEPTEMBER 2022 • PREVIOUS VERSION IS NO LONGER VALID. • © COPYRIGHT 2022 BY THERMACUT® CZECH REPUBLIC. ALL RIGHTS RESERVED.

THERMACUT® REPLACEMENT PARTS SUITABLE FOR TRUMPF®

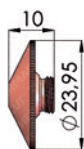

HG10.150–HG10.153
HG10.148
HG10.159



HG10.150/C–HG10.152/C
HG10.148/C

Standard copper nozzles / Standard copper nozzles with hard chromium plating

Part No.	Ref. No.	Description	Std. Pkg.	Part No.	Ref. No.	Description	Std. Pkg.
HG10.150	0124561	Nozzle ECE 0.8mm	10pcs	HG10.154	0237501	Nozzle ECE 1.7mm	10pcs
HG10.150/C	0352280	Nozzle ECE 0.8mm HCP	10pcs	HG10.154/C	0352284	Nozzle ECE 1.7mm HCP	10pcs
HG10.151	0124562	Nozzle ECE 1.0mm	10pcs	HG10.155	1253211	Nozzle ECE 2.0mm	10pcs
HG10.151/C	0352281	Nozzle ECE 1.0mm HCP	10pcs	HG10.155/C	1253212	Nozzle ECE 2.0mm HCP	10pcs
HG10.148	0966809	Nozzle ECE 1.2mm	10pcs	HG10.158	0126933	Nozzle ECE 2.3mm	10pcs
HG10.148/C	0352282	Nozzle ECE 1.2mm HCP	10pcs	HG10.158/C	0352285	Nozzle ECE 2.3mm HCP	10pcs
HG10.152	0237497	Nozzle ECE 1.4mm with step	10pcs	HG10.156	HG10.156	Nozzle ECE 2.5mm	10pcs
HG10.152/C	0352283	Nozzle ECE 1.4mm HCP	10pcs	HG10.149	0942742	Nozzle ECE 2.7mm	10pcs
HG10.159	237497-S	Nozzle ECE 1.4mm with Straith Taper	10pcs	HG10.149/C	0352286	Nozzle ECE 2.7mm HCP	10pcs
HG10.153	237500	Nozzle ECE 1.5mm	10pcs	HG10.157	0237504	Nozzle ECE 3.0mm	10pcs

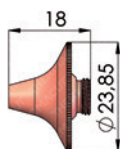

HG10.130–HG10.133

Part No.	Ref. No.	Description	Std. Pkg.	Part No.	Ref. No.	Description	Std. Pkg.
HG10.130	1277773	Nozzle 0.8mm	10pcs	HG10.134	1277779	Nozzle 1.7mm	10pcs
HG10.131	1277771	Nozzle 1.0mm	10pcs	HG10.135 OD	1277780	Nozzle 2.0mm	10pcs
HG10.132	1277774	Nozzle 1.2mm	10pcs	HG10.136	1277781	Nozzle 2.3mm	10pcs
HG10.133	1277776	Nozzle 1.4mm	10pcs	HG10.137 OD	1277782	Nozzle 2.7mm	10pcs

OD ON DEMAND – WE DO NOT KEEP THESE PARTS IN STOCK, COST IS SET ACCORDING TO THE ORDERED QUANTITY, DELIVERY TIME MAY DIFFER FROM STANDARD PRODUCTS.

Last update of this page: 08/02/2022. See Revision history for details.

THERMACUT®
THE CUTTING COMPANY®

WWW.THERMACUT.COM
TEL.: +420 556 423 440
SALES@THERMACUT.CZ

THERMACUT®, THE CUTTING COMPANY®, FHT-EX®, EX-TRAFIRE®, EX-TRACK®, EX-TRABEAM® AND EX-TRAFLEAME® ARE REGISTERED TRADEMARKS OF THERMACUT, K.S. AND MAY BE REGISTERED IN CZECH REPUBLIC AND/OR OTHER COUNTRIES. ALL OTHER TRADEMARKS ARE PROPERTIES OF THEIR RESPECTIVE OWNERS. THERMACUT® IS IN NO WAY AFFILIATED WITH TRUMPF®. MOST THERMACUT® PARTS ARE MADE FOR OR BY AN IBG COMPANY.
VALID FROM SEPTEMBER 2022 • PREVIOUS VERSION IS NO LONGER VALID. • © COPYRIGHT 2022 BY THERMACUT® CZECH REPUBLIC. ALL RIGHTS RESERVED.

THERMACUT® REPLACEMENT PARTS SUITABLE FOR TRUMPF®

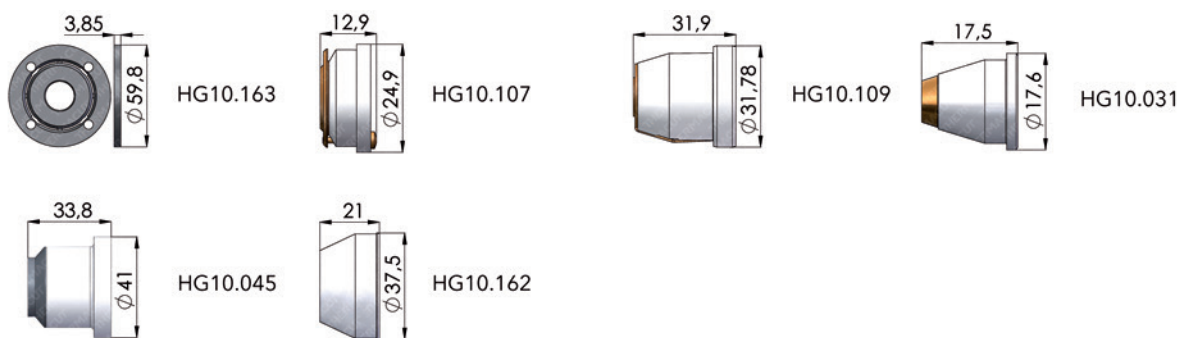

Part No.	Ref. No.	Description	Std. Pkg.
HG10.163	234485	Break Away Bar	1pc
HG10.107	0258809	Ceramic Nozzle Holder (Lasermatic®)	1pc
HG10.109	0260432	Ceramic Nozzle Holder DIAS III	1pc
HG10.031	0936678	Ceramic Nozzle Holder M6	1pc
HG10.045	1906032	Ceramic Nozzle Holder M12	1pc
HG10.080	1755673	Nozzle Holder M12	1pc
HG10.162	256153	PTFE Cover DIAS III White	1pc
HG10.162/1	0955826	PTFE Cover DIAS III Black	1pc

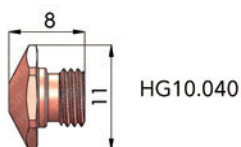

Part No.	Ref. No.	Description	Std. Pkg.
HG10.040	1589610	Nozzle - 2.0mm Blow Off	1pc

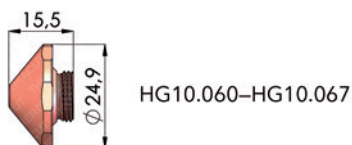

Part No.	Ref. No.	Description	Std. Pkg.	Part No.	Ref. No.	Description	Std. Pkg.
HG10.060	1324858	Nozzle EAA 0.8mm	10pcs	HG10.070	1373324	Nozzle EAB 0.8mm	10pcs
HG10.061	1324860	Nozzle EAA 1.0mm	10pcs	HG10.071	1373325	Nozzle EAB 1.0mm	10pcs
HG10.062	1324861	Nozzle EAA 1.2mm	10pcs	HG10.072	1373326	Nozzle EAB 1.2mm	10pcs
HG10.063	1324863	Nozzle EAA 1.4mm	10pcs	HG10.073	1373327	Nozzle EAB 1.4mm	10pcs
HG10.064	1324864	Nozzle EAA 1.7mm	10pcs	HG10.074	1373328	Nozzle EAB 1.7mm	10pcs
HG10.065	1324865	Nozzle EAA 2.0mm	10pcs	HG10.075	1373329	Nozzle EAB 2.0mm	10pcs
HG10.066	1324866	Nozzle EAA 2.3mm	10pcs	HG10.076	1373330	Nozzle EAB 2.3mm	10pcs
HG10.067	1324867	Nozzle EAA 2.7mm	10pcs	HG10.077	1373331	Nozzle EAB 2.7mm	10pcs

PolyTetraFluoroEthylene is a fluorocarbon-based polymer and is commonly abbreviated PTFE. The Teflon® brand of PTFE is manufactured only by DuPont® and is not sold by THERMACUT®. THERMACUT® purchases other brands of PTFE from various high quality manufacturers.

Last update of this page: 10/05/2021. See Revision history for details.

THERMACUT®
THE CUTTING COMPANY®

WWW.THERMACUT.COM
TEL.: +420 556 423 440
SALES@THERMACUT.CZ

THERMACUT®, THE CUTTING COMPANY®, FHT-EX®, EX-TRAFIRE®, EX-TRACK®, EX-TRABEAM® AND EX-TRAFLEAME® ARE REGISTERED TRADEMARKS OF THERMACUT, K.S. AND MAY BE REGISTERED IN CZECH REPUBLIC AND/OR OTHER COUNTRIES. ALL OTHER TRADEMARKS ARE PROPERTIES OF THEIR RESPECTIVE OWNERS. THERMACUT® IS IN NO WAY AFFILIATED WITH TRUMPF® AND E.I. DU PONT DE NEMOURS AND COMPANY. MOST THERMACUT® PARTS ARE MADE FOR OR BY AN IBG COMPANY.
VALID FROM SEPTEMBER 2022 • PREVIOUS VERSION IS NO LONGER VALID. • © COPYRIGHT 2022 BY THERMACUT® CZECH REPUBLIC. ALL RIGHTS RESERVED.

THERMACUT® REPLACEMENT PARTS SUITABLE FOR TRUMPF®
PARTS SUITABLE FOR TRUMPF® BRIGHTLINE™ SERIES AND COOLLINE™ SERIES

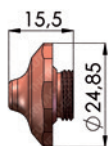

HG10.081–HG10.086

Part No.	Ref. No.	Description	Std. Pkg.	Part No.	Ref. No.	Description	Std. Pkg.
HG10.081	1664569	BrightLine™ Nozzle EAN 1.7mm	1pc	HG10.087	1809421	BrightLine™ Nozzle EAQ 7.5mm	1pc
HG10.082	1664602	BrightLine™ Nozzle EAN 2.0mm	1pc	HG10.088	1886199	BrightLine™ Nozzle EAQ 9.5mm	1pc
HG10.083	1664625	BrightLine™ Nozzle EAN 2.5mm	1pc	HG10.089	1774018	CoolLine™ Nozzle EFL 1.4mm	1pc
HG10.084	1835747	BrightLine™ Nozzle EAK 4.0mm	1pc	HG10.090	1774020	CoolLine™ Nozzle EFL 2.0mm	1pc
HG10.085	1633046	BrightLine™ Nozzle EAC 5.3mm	1pc	HG10.091	1774092	CoolLine™ Nozzle EFL 2.3mm	1pc
HG10.086	1809091	BrightLine™ Nozzle EAQ 6.0mm	1pc				

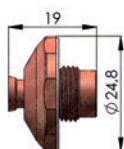

HG10.092–HG10.095

Part No.	Ref. No.	Description	Std. Pkg.
HG10.092	1879940	CoolLine™ Nozzle EGL D1.4	10pcs
HG10.093	1879951	CoolLine™ Nozzle EGL D1.7	10pcs
HG10.094	1879952	CoolLine™ Nozzle EGL D2.0	10pcs
HG10.095	1879953	CoolLine™ Nozzle EGL D2.3	10pcs

Last update of this page: 10/05/2021. See Revision history for details.

THERMACUT® REPLACEMENT PARTS SUITABLE FOR TRUMPF®
PARTS SUITABLE FOR TRUMPF® PERFORMANCE™ SERIES



HG10.096–HG10.098

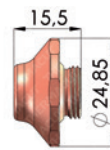

HG10.870

Part No.	Ref. No.	Description	Std. Pkg.	Part No.	Ref. No.	Description	Std. Pkg.
HG10.096	2059462	Nozzle EAU 2.5mm	10pcs	HG10.041	2253595	Nozzle EAU 10.0mm	10pcs
HG10.097	2060001	Nozzle EAU 3.0mm	10pcs	HG10.870	2491660	Nozzle CAU 10.0mm	10pcs
HG10.098	2060004	Nozzle EAU 4.0mm	10pcs				
HG10.099	2060025	Nozzle EAU 6.0mm	10pcs				

THERMACUT® REPLACEMENT PARTS SUITABLE FOR TRUMPF®

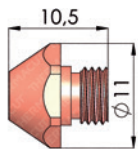

HG10.036–HG10.038
 HG10.010–HG10.012
 HG10.025
 HG10.028

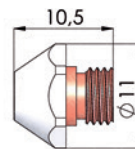

HG10.036/C
 HG10.010/C–HG10.012/C
 HG10.028/C

Part No.	Ref. No.	Description	Std. Pkg.	Part No.	Ref. No.	Description	Std. Pkg.
HG10.036	1354230	Nozzle EBD 0.8mm	10pcs	HG16.600	HG16.600	Nozzle 0.8mm	10pcs
HG10.301	1384753	Crossjet 2.0mm	10pcs	HG10.013	226939	Nozzle 1.0mm	10pcs
HG10.036/C OD	1354230CP	Nozzle EBD 0.8mm HCP	10pcs	HG10.026 OD	HG10.026	Nozzle 1.0mm HD	10pcs
HG10.010	0212334	Nozzle EBD 1.0mm	10pcs	HG10.014	226940	Nozzle 1.4mm HD	10pcs
HG10.010/C	0212334CP	Nozzle EBD 1.0mm HCP	10pcs	HG10.015	227144	Nozzle 1.7mm HD	10pcs
HG10.025	HG10.025	Nozzle 1.0mm HD	10pcs	HG10.033	HG10.033	Nozzle 2.0mm HD	10pcs
HG10.037	1479581	Nozzle EBD 1.2mm	10pcs	HG10.029	HG10.029	Nozzle 2.3mm HD	10pcs
HG10.011	0216199	Nozzle EBD 1.4mm HD	10pcs				
HG10.011/C	0216199CP	Nozzle EBD 1.4mm HD HCP	10pcs				
HG10.012	0225213	Nozzle EBD 1.7mm HD	10pcs				
HG10.012/C	0225213CP	Nozzle EBD 1.7mm HD HCP	10pcs				
HG10.038	1487009	Nozzle EBD 2.0mm	10pcs				
HG10.028	0126156	Nozzle EBD 2.3mm HD	10pcs				
HG10.028/C OD	0126156CP	Nozzle EBD 2.3mm HD HCP	10pcs				

OD ON DEMAND – WE DO NOT KEEP THESE PARTS IN STOCK, COST IS SET ACCORDING TO THE ORDERED QUANTITY, DELIVERY TIME MAY DIFFER FROM STANDARD PRODUCTS.

Last update of this page: 27/06/2022. See Revision history for details.

THERMACUT® REPLACEMENT PARTS SUITABLE FOR TRUMPF®

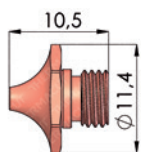

HG10.016

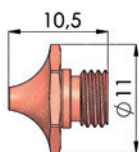

HG10.017
HG10.030

Part No.	Ref. No.	Description	Std. Pkg.	Part No.	Ref. No.	Description	Std. Pkg.
HG10.016	HG10.016	Nozzle 1.0mm	10pcs	HG10.225	0135320	Nozzle 1.0mm RE	10pcs
HG10.017	HG10.017	Nozzle 1.4mm HD	10pcs	HG10.226	HG10.226	Nozzle 1.2mm RE	10pcs
HG10.030 OD	HG10.030	Nozzle 2.3mm HD	10pcs	HG10.220 OD	0135318	Nozzle 1.4mm RE	10pcs
				HG10.221 OD	0126157	Nozzle 1.7mm RE	10pcs

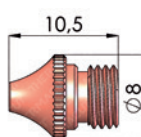

HG10.020-HG10.022
HG10.039

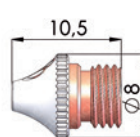

HG10.020/C
HG10.021/C

Part No.	Ref. No.	Description	Std. Pkg.	Part No.	Ref. No.	Description	Std. Pkg.
HG10.020	0913799	Nozzle EBG 0.8mm HD	10pcs	HG10.022/C	0913801CP	Nozzle EBG 1.4mm HD HCP	10pcs
HG10.020/C OD	0913799CP	Nozzle EBG 0.8mm HD HCP	10pcs	HG10.023	0937988	Nozzle EBG 1.7mm HD	10pcs
HG10.021	0913800	Nozzle EBG 1.0mm HD	10pcs	HG10.023/C	0937988CP	Nozzle EBG 1.7mm HD HCP	10pcs
HG10.021/C	0913800CP	Nozzle EBG 1.0mm HD HCP	10pcs	HG10.027	1487036	Nozzle EBG 2.0mm	10pcs
HG10.039	1487034	Nozzle EBG 1.2mm	10pcs	HG10.024	0937989	Nozzle EBG 2.3mm HD	10pcs
HG10.022	0913801	Nozzle EBG 1.4mm HD	10pcs	HG10.024/C	0937989CP	Nozzle 2.3mm HD HCP	10pcs

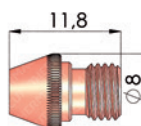

HG10.020-HG10.022

Part No.	Ref. No.	Description	Std. Pkg.	Part No.	Ref. No.	Description	Std. Pkg.
HG10.900	2241407-UR	Nozzle EBC X12	10pcs	HG10.904	2241409-UR	Nozzle EBC X40	10pcs
HG10.901	2085524-UR	Nozzle EBC X20	10pcs				
HG10.902	2241406-UR	Nozzle EBC X31	10pcs				
HG10.903	2241524-UR	Nozzle EBC X35	10pcs				

OD ON DEMAND – WE DO NOT KEEP THESE PARTS IN STOCK, COST IS SET ACCORDING TO THE ORDERED QUANTITY, DELIVERY TIME MAY DIFFER FROM STANDARD PRODUCTS.

Last update of this page: 22/08/2022. See Revision history for details.

THERMACUT®
THE CUTTING COMPANY®

WWW.THERMACUT.COM
TEL.: +420 556 423 440
SALES@THERMACUT.CZ

THERMACUT®, THE CUTTING COMPANY®, FHT-EX®, EX-TRAFIRE®, EX-TRACK®, EX-TRABEAM® AND EX-TRAFLEAME® ARE REGISTERED TRADEMARKS OF THERMACUT, K.S. AND MAY BE REGISTERED IN CZECH REPUBLIC AND/OR OTHER COUNTRIES. ALL OTHER TRADEMARKS ARE PROPERTIES OF THEIR RESPECTIVE OWNERS. THERMACUT® IS IN NO WAY AFFILIATED WITH TRUMPF®. MOST THERMACUT® PARTS ARE MADE FOR OR BY AN IBG COMPANY.
VALID FROM SEPTEMBER 2022 • PREVIOUS VERSION IS NO LONGER VALID. • © COPYRIGHT 2022 BY THERMACUT® CZECH REPUBLIC. ALL RIGHTS RESERVED.

THERMACUT® REPLACEMENT PARTS SUITABLE FOR TRUMPF®
OPTICS, SERVICE ITEMS AND SPARE PARTS
SUITABLE FOR TRUMPF®



LENSES SUITABLE FOR TRUMPF®

Part No.	Ref. No.	Description	Std. Pkg.	Part No.	Ref. No.	Description	Std. Pkg.
HG10.166/H	346104	3.75" ZnSe Meniscus lens High pressure lens (29bar), 38.1mm Effective focal length: 95.3mm Edge thickness: 7.4mm AR/AR for 10.6µm (absorption <0.20%)	1pc	HG10.167/HU	88114	5.00" ZnSe Meniscus lens - ULTRA LOW High pressure lens (29bar), 38.1mm Effective focal length: 127.0mm Edge thickness: 7.4mm AR/AR for 10.6µm (absorption <0.13%)	1pc
HG10.167/H	88114	5.00" ZnSe Meniscus lens High pressure lens (29bar), 38.1mm Effective focal length: 127.0mm Edge thickness: 7.4mm AR/AR for 10.6µm (absorption <0.20%)	1pc	HG10.168/HU	97517	7.50" ZnSe Meniscus lens - ULTRA LOW High pressure lens (29bar), 38.1mm Effective focal length: 190.5mm Edge thickness: 7.4mm AR/AR for 10.6µm (absorption <0.13%)	1pc
HG10.168/H	97517	7.50" ZnSe Meniscus lens High pressure lens (29bar), 38.1mm Effective focal length: 190.5mm Edge thickness: 7.4mm AR/AR for 10.6µm (absorption <0.20%)	1pc				
HG10.169/H	141972	9.00" ZnSe Meniscus lens High pressure lens (29bar), 38.1mm Effective focal length: 225.0mm Edge thickness: 7.4mm AR/AR for 10.6µm (absorption <0.20%)	1pc				
HG10.179/H	350163	10.00" ZnSe Meniscus lens High pressure lens (29bar), 38.1mm Effective focal length: 254.0mm Edge thickness: 7.4mm AR/AR for 10.6µm (absorption <0.20%)	1pc				

Part No.	Ref. No.	Description	Std. Pkg.	Part No.	Ref. No.	Description	Std. Pkg.
HG10.119/H*	HG10.119/H	ZnSe 50mm Lens ET8.9 FL170mm - w/o chip	1pc	HG10.126/H*	HG10.126/H	ZnSe 40mm Lens ET7.5 FL250mm - w/o chip	1pc
HG10.120/H*	HG10.120/H	ZnSe 50mm Lens ET8.9 FL175mm - w/o chip	1pc	HG10.127/H*	HG10.127/H	ZnSe 40 mm Lens ET7.5 FL130mm - chip	1pc
HG10.121/H*	HG10.121/H	ZnSe 50mm Lens ET8.9 FL250mm - w/o chip	1pc	HG10.128/H*	HG10.128/H	ZnSe 40 mm Lens ET7.5 FL250mm - chip	1pc
HG10.123/H*	HG10.123/H	ZnSe 50mm Lens ET8.9 FL250mm - chip	1pc	HG10.129/H*	HG10.129/H	ZnSe 40 mm Lens ET7.4 FL240mm Meniscus	1pc
HG10.124/H*	HG10.124/H	ZnSe 40mm Lens ET7.5 FL155mm - w/o chip	1pc				
HG10.125/H*	HG10.125/H	ZnSe 40mm Lens ET7.5 FL130mm - w/o chip	1pc				

PROTECTION WINDOWS SUITABLE FOR TRUMPF®

Part No.	Ref. No.	Description	Std. Pkg.
HG17.513	1614767	Protection Window D34.00mm × ET = 5.0mm	1pc
HG17.515	759720	Protection Window D55.00mm × ET = 1.50mm	1pc
HG17.526	766719	Protection Window D30.00mm × ET = 5.0mm	1pc

Last update of this page: 22/08/2022. See Revision history for details.

THERMACUT® REPLACEMENT PARTS SUITABLE FOR TRUMPF®

OPTICS, SERVICE ITEMS AND SPARE PARTS SUITABLE FOR TRUMPF®

ACCESSORIES SUITABLE FOR TRUMPF®

Part No.	Ref. No.	Description	Std. Pkg.
HG10.174	HG10.174	Polish for laser optics, 250ml, 0367432/2243066	1pc
HG10.173	HG10.173	Lens cleaning paper from TIFFEN®, sheet size 70 × 115mm	50pcs
HG15.136 OD	HG15.136	Latex gloves	100pcs

BELLOWS SUITABLE FOR TRUMPF® TC L3030™ AND L3020™

Part No.	Ref. No.	Description	Std. Pkg.	Part No.	Ref. No.	Description	Std. Pkg.
HG17.100 OD	921742	Bellow x-axis	1pc	HG17.104 OD	1667801	Chest bellow y-axis right (old No. 920716)	1pc
HG17.101 OD	141394	Bellow y-axis	1pc	HG17.105 OD	1667805	Chest bellow y-axis left (old No. 939016)	1pc
HG17.102 OD	1667790	Chest bellow x-axis front (old No. 920715)	1pc	HG17.106 OD	910354	Chest bellow z-axis	1pc
HG17.103 OD	1667803	Chest bellow x-axis rear (old No. 9390015)	1pc				

BELLOWS SUITABLE FOR TRUMPF® TC L4030™

Part No.	Ref. No.	Description	Std. Pkg.	Part No.	Ref. No.	Description	Std. Pkg.
HG17.110 OD	921870	Bellow x-axis	1pc	HG17.115 OD	920719	Chest bellow y-axis right	1pc
HG17.111 OD	144949	Bellow y-axis	1pc	HG17.116 OD	938000	Chest bellow y-axis left	1pc
HG17.112 OD	939017	Chest bellow x-axis rear	1pc	HG17.106 OD	910354	Chest bellow z-axis	1pc
HG17.113 OD	976624	Chest bellow x-axis front	1pc				

BELLOWS SUITABLE FOR TRUMPF® TC L3050™

Part No.	Ref. No.	Description	Std. Pkg.	Part No.	Ref. No.	Description	Std. Pkg.
HG17.122 OD	1302020	Bellow x-axis front and middle left (Altern. No. 981757/1596087)	1pc	HG17.128 OD	979561	Bellow z-axis rear	1pc
HG17.123 OD	981710	Bellow x-axis front and rear right	1pc	HG17.119 OD	1226192	Disc bellow y-axis left (Altern. No. 1353514)	1pc
HG17.124	1307207	Bellow x-axis front and rear right (Altern. No. 1596086)	1pc	HG17.120 OD	1271514	Chest bellow u/x-axis front and rear (Altern. No. 978079)	1pc
HG17.125	1302018	Bellow x-axis rear left (Altern. No. 981756/1596088)	1pc	HG17.106 OD	910354	Chest bellow z-axis	1pc
HG17.126 OD	1226193	Bellow y-axis right	1pc				
HG17.127 OD	1302386	Bellow u-axis front and rear (Altern. No. 981753)	1pc				

* BEFORE PURCHASING LENSES, PLEASE CHECK THE COUNTRY OF ORIGIN FOR POSSIBLE IMPORT RESTRICTIONS WITH YOUR SALES REPRESENTATIVE.

OD ON DEMAND – WE DO NOT KEEP THESE PARTS IN STOCK, COST IS SET ACCORDING TO THE ORDERED QUANTITY, DELIVERY TIME MAY DIFFER FROM STANDARD PRODUCTS.

W/O WITHOUT

Last update of this page: 22/08/2022. See Revision history for details.

THERMACUT® REPLACEMENT PARTS SUITABLE FOR TRUMPF®
SERVICE ITEMS AND SPARE PARTS SUITABLE FOR TRUMPF®

BELLOWS SUITABLE FOR TRUMPF® TC L4050™

Part No.	Ref. No.	Description	Std. Pkg.	Part No.	Ref. No.	Description	Std. Pkg.
HG17.140	OD 1222529	Bellow x-axis front and middle left	1pc	HG17.146	OD 1222575	Disc bellow x-axis left	1pc
HG17.141	OD 1222573	Bellow x-axis front and rear right	1pc	HG17.147	OD 1222576	Disc bellow x-axis right	1pc
HG17.142	OD 1222571	Bellow x-axis rear left	1pc	HG17.148	OD 1222110	Disk bellow y-axis left	1pc
HG17.143	OD 1222111	Bellow y-axis right	1pc	HG17.106	OD 910354	Chest bellow z-axis	1pc
HG17.144	OD 1222528	Bellow u-axis front and rear	1pc				
HG17.128	OD 979561	Bellow z-axis rear	1pc				

BELLOWS SUITABLE FOR TRUMPF® TC L6030™

Part No.	Ref. No.	Description	Std. Pkg.	Part No.	Ref. No.	Description	Std. Pkg.
HG17.150	OD 921871	Bellows x-axis on request	1pc	HG17.115	OD 920719	Chest bellows y-axis right	1pc
HG17.111	OD 144949	Bellows y-axis	1pc	HG17.116	OD 938000	Chest bellows y-axis left	1pc
HG17.151	OD 920730	Chest bellows x-axis rear on request	1pc	HG17.106	OD 910354	Chest bellows z-axis	1pc
HG17.152	OD 937999	Chest bellows x-axis front on request	1pc				

BELLOWS SUITABLE FOR TRUMPF® TC L6050™

Part No.	Ref. No.	Description	Std. Pkg.	Part No.	Ref. No.	Description	Std. Pkg.
HG17.153	OD 1251452	Bellows x-axis right	1pc	HG17.143	OD 1222111	Bellows y-axis righth	1pc
HG17.154	OD 1251453	Bellows x-axis left	1pc	HG17.158	OD 1353516	Disk bellows y-axis left	1pc
HG17.155	OD 1251454	Bellows x-axis left	1pc	HG17.159	OD 1306473	Disk bellows x-axis left	1pc
HG17.156	OD 1251455	Bellows u-axis	1pc	HG17.160	OD 1306474	Disk bellows x-axis right	1pc

BELLOWS SUITABLE FOR TRUMPF® L3030™ (L20™)

Part No.	Ref. No.	Description	Std. Pkg.	Part No.	Ref. No.	Description	Std. Pkg.
HG17.161	OD 1458867	Railing cover left	1pc	HG17.165	OD 1496435	Disk Bellows y-axis right	1pc
HG17.162	OD 1458866	Railing cover right	1pc	HG17.166	OD 1458860	Disk Bellows	1pc
HG17.163	OD 1512607	Chest bellows z-axis	1pc	HG17.167	1458861/1854032	Disk Bellows	1pc
HG17.164	OD 1496436	Disk Bellows y-axis left	1pc				

OD ON DEMAND – WE DO NOT KEEP THESE PARTS IN STOCK, COST IS SET ACCORDING TO THE ORDERED QUANTITY, DELIVERY TIME MAY DIFFER FROM STANDARD PRODUCTS.

Last update of this page: 08/02/2022. See Revision history for details.

THERMACUT® REPLACEMENT PARTS SUITABLE FOR TRUMPF® SERVICE ITEMS AND SPARE PARTS SUITABLE FOR TRUMPF®

FILTER ELEMENTS SUITABLE FOR TRUMPF®

Part No.	Ref. No.	Description	Std. Pkg.
HG17.130	146152	Chisso filter CP10 for water circuit 30 × 68 × 248mm	1pc
HG17.131	123674 / 377006	Filter element Air/N2	1pc
HG17.132	123675 / 377005	Filter element FFP3	1pc
HG17.133	123676 / 377004	Filter element AKP 04/20S	1pc
HG17.134	365781	Filter MPF 04/10	1pc
HG17.135	365782	Filter SMPF 04/10	1pc
HG17.020	941996 / 0149023	Circuit lubricated rotary valve - Vacuum pump - original HYCO®	1pc
HG17.000	0345064	Filter panel suitable for extraction unit 556 × 74 × 1050mm, H13 suitable for TC L3030™, L4050™, L6050™, L4030™, L6030™, L3020™, L3050™	1pc
HG17.001	OD 0139809	Filter panel suitable for extraction unit 500 × 600mm, H13 suitable for TUBEMATIC®, TC600L™, TC6000L™	1pc
HG17.002	OD 146122342682	Filter panel suitable for extraction unit (horizontal)	1pc
HG17.003	380757	Filter panel suitable for extraction unit 685 × 100 × 1043mm	1pc

AIR FILTERS SUITABLE FOR TRUMPF®

Part No.	Ref. No.	Description	Std. Pkg.	Part No.	Ref. No.	Description	Std. Pkg.
HG10.188	HG10.188	Air filter for cooling aggregate size: 1670 × 660 × 8mm	25pcs	HG11.175	OD HG11.175	Air filter for cooling aggregate size: 670 × 1200 × 8mm	25pcs
HG11.188	OD HG11.188	Air filter for cooling aggregate size: 1670 × 620 × 8mm	25pcs	HG11.178	OD HG11.178	Air filter for cooling aggregate size: 2500 × 1710 × 8mm	5pcs
HG10.189	OD HG10.189	Air filter for cooling aggregate size: 2420 × 560 × 8mm	25pcs	HG11.187	OD HG11.187	Air filter for cooling aggregate size 1530 × 1530 × 8mm	5pcs
HG11.174	OD HG11.174	Air filter for cooling aggregate size: 3000 × 1800 × 8mm	5pcs	HG10.176	OD HG10.176	Air filter for cooling aggregate size: 800 × 600 × 8mm	25pcs
HG10.190	HG10.190	Air filter for cooling aggregate size: 1200 × 700 × 8mm	25pcs				

WATER FILTERS SUITABLE FOR TRUMPF®

Part No.	Ref. No.	Description	Std. Pkg.
HG17.136	HG17.136	Water filter 20"	1pc

OD ON DEMAND – WE DO NOT KEEP THESE PARTS IN STOCK, COST IS SET ACCORDING TO THE ORDERED QUANTITY, DELIVERY TIME MAY DIFFER FROM STANDARD PRODUCTS.

Last update of this page: 14/09/2022. See Revision history for details.

THERMACUT® REPLACEMENT PARTS SUITABLE FOR RAYTOOLS™

Part No.	Ref. No.	Description	Std. Pkg.	Part No.	Ref. No.	Description	Std. Pkg.
HG11.051	120GJT0508	Nozzle 0.8mm	10pcs	HG11.061	120GJT0610	Double Nozzle 1.0mm HCP	10pcs
HG11.052	120GJT0510	Nozzle 1.0mm	10pcs	HG11.062	120GJT0612	Double Nozzle 1.2mm HCP	10pcs
HG11.053	120GJT0512	Nozzle 1.2mm	10pcs	HG11.063	120GJT0615	Double Nozzle 1.5mm HCP	10pcs
HG11.054	120GJT0515	Nozzle 1.5mm	10pcs	HG11.064	120GJT0620	Double Nozzle 2.0mm HCP	10pcs
HG11.055	120GJT0520	Nozzle 2.0mm	10pcs	HG11.065	120GJT0625	Double Nozzle 2.5mm HCP	10pcs
HG11.056	120GJT0525	Nozzle 2.5mm	10pcs	HG11.066	120GJT0630	Double Nozzle 3.0mm HCP	10pcs
HG11.057	120GJT0530	Nozzle 3.0mm	10pcs	HG11.067	120GJT0635	Double Nozzle 3.5mm HCP	10pcs
HG11.058	120GJT0535	Nozzle 3.5mm	10pcs	HG11.068	120GJT0640	Double Nozzle 4.0mm HCP	10pcs
HG11.059	120GJT0540	Nozzle 4.0mm	10pcs	HG11.069	HG11.069	Protection Window 27.9 × 4.1	1pc
HG11.060	120GJT0608	Double Nozzle 0.8mm HCP	10pcs	HG11.050	120274100B	Nozzle Holder	1pc

THERMACUT® REPLACEMENT PARTS SUITABLE FOR BODOR™

Part No.	Ref. No.	Description	Std. Pkg.	Part No.	Ref. No.	Description	Std. Pkg.
HG11.070	HG11.070	Nozzle 0.8mm	10pcs	HG11.082	HG11.082	Double Nozzle 1.0mm	10pcs
HG11.071	HG11.071	Nozzle 1.0mm	10pcs	HG11.083	HG11.083	Double Nozzle 1.2mm	10pcs
HG11.072	HG11.072	Nozzle 1.2mm	10pcs	HG11.084	HG11.084	Double Nozzle 1.5mm	10pcs
HG11.073	HG11.073	Nozzle 1.5mm	10pcs	HG11.085	HG11.085	Double Nozzle 2.0mm	10pcs
HG11.074	HG11.074	Nozzle 2.0mm	10pcs	HG11.086	HG11.086	Double Nozzle 2.5mm	10pcs
HG11.075	HG11.075	Nozzle 2.5mm	10pcs	HG11.087	HG11.087	Double Nozzle 3.0mm	10pcs
HG11.076	HG11.076	Nozzle 3.0mm	10pcs	HG11.088	HG11.088	Double Nozzle 3.5mm	10pcs
HG11.077	HG11.077	Nozzle 3.5mm	10pcs	HG11.089	HG11.089	Double Nozzle 4.0mm	10pcs
HG11.078	HG11.078	Nozzle 4.0mm	10pcs	HG11.090	HG11.090	Double Nozzle 4.5mm	10pcs
HG11.079	HG11.079	Nozzle 4.5mm	10pcs	HG11.091	HG11.091	Double Nozzle 5.0mm	10pcs
HG11.080	HG11.080	Nozzle 5.0mm	10pcs	HG17.524	P0595-56801	Protection Window D37.00mm × ET = 7.0mm	1pc
HG11.081	HG11.081	Double Nozzle 0.8mm	10pcs	HG11.050	120274100B	Nozzle Holder	1pc

Last update of this page: 10/05/2021. See Revision history for details.

THERMACUT®
THE CUTTING COMPANY®

WWW.THERMACUT.COM
TEL.: +420 556 423 440
SALES@THERMACUT.CZ

THERMACUT®, THE CUTTING COMPANY®, FHT-EX®, EX-TRAFIRE®, EX-TRACK®, EX-TRABEAM® AND EX-TRAFLEAME® ARE REGISTERED TRADEMARKS OF THERMACUT, K.S. AND MAY BE REGISTERED IN CZECH REPUBLIC AND/OR OTHER COUNTRIES. ALL OTHER TRADEMARKS ARE PROPERTIES OF THEIR RESPECTIVE OWNERS. THERMACUT® IS IN NO WAY AFFILIATED WITH BODOR™ AND RAYTOOLS™. MOST THERMACUT® PARTS ARE MADE FOR OR BY AN IBG COMPANY.
VALID FROM SEPTEMBER 2022 • PREVIOUS VERSION IS NO LONGER VALID. • © COPYRIGHT 2022 BY THERMACUT® CZECH REPUBLIC. ALL RIGHTS RESERVED.

REVISION HISTORY

INTRODUCTORY SECTION - Revision on PAGE 3 - 14/09/2022 - Croatian address changed.

TRUMPF® SECTION - Revision on PAGE 41 - 14/09/2022 - Product line added.

AMADA® SECTION - Revision on PAGES 8, 9 - 22/08/2022 - Parts HG11.521, HG11.522 moved to page 8.

Precitec® SECTION - Revision on PAGE 26 - 22/08/2022 - Part HG11.107 removed from the table.

PRIMA POWER® SECTION - Revision on PAGE 31 - 22/08/2022 - Part HG10.777 removed from the picture and from the table.

PRIMA POWER® SECTION - Revision on PAGE 32 - 22/08/2022 - Parts HG11.380/C, HG11.383/C removed from the table.

TRUMPF® SECTION - Revision on PAGE 37 - 22/08/2022 - ON DEMAND (OD) information added to HG10.221.

TRUMPF® SECTION - Revision on PAGES 38, 39 - 22/08/2022 - Lenses table moved to page 39. Accessories table moved to page 38.

AMADA® SECTION - Revision on PAGE 8 - 27/06/2022 - Part HG10.509 removed from the picture and from the table.

AMADA® SECTION - Revision on PAGE 9 - 27/06/2022 - Parts HG12.506, HG12.510, HG12.521 removed from the picture and from the table. Part HG12.532 removed from the table.

BYSTRONIC® SECTION - Revision on PAGE 11 - 27/06/2022 - Part HG10.469 removed from the picture and from the table.

BYSTRONIC® SECTION - Revision on PAGE 12 - 27/06/2022 - Parts HG10.423/C, HG10.425/C, HG10.424/C, HG10.422/D removed from the table.

MAZAK® SECTION - Revision on PAGE 15 - 27/06/2022 - Parts HG10.653, HG10.654 removed from the picture and from the table.

MAZAK® SECTION - Revision on PAGE 15 - 27/06/2022 - Parts HG10.326, HG10.307, HG10.324 removed from the picture and from the table. Parts HG10.478, HG10.480, HG10.481, HG10.482 removed from the table.

MAZAK® SECTION - Revision on PAGES 15, 19 - 27/06/2022 - Parts HG10.289, HG10.293 removed from the table.

MAZAK® SECTION - Revision on PAGE 16 - 27/06/2022 - Part HG10.674 removed from the picture and from the table.

MAZAK® SECTION - Revision on PAGE 16 - 27/06/2022 - Parts HG10.631, HG10.696/D, HG10.697/D, HG10.707, HG10.710 removed from the table. Parts HG10.691/D, HG10.699, HG10.692/D removed from the picture and from the table.

MAZAK® SECTION - Revision on PAGE 18 - 27/06/2022 - Parts HG10.326, HG10.307, HG10.324 removed from the picture and from the table. Parts HG10.478, HG10.480 removed from the table.

MAZAK® SECTION - Revision on PAGE 20 - 27/06/2022 - Parts HG10.691/D, HG10.699, HG10.692/D removed from the picture and from the table. Parts HG10.696/D, HG10.697/D removed from the table.

MITSUBISHI® SECTION - Revision on PAGE 23 - 27/06/2022 - Parts HG12.500, HG12.528, HG12.506, HG12.521 removed from the picture and from the table. Parts HG12.503, HG12.529, HG12.542, HG12.552, HG12.553, HG12.532 removed from the table.